



VIVIX®

A FRESH PERSPECTIVE IN ARCHITECTURAL PANELS *by* FORMICA GROUP



be  
VIVIX®

In your hands is the latest in lightweight, exterior surfacing by Formica Group.  
The innovative, high quality, practical and durable solution for all your projects.  
Be the architect who envisions with the heart and creates with the mind.  
Unleash your imagination. Be fresh, authentic, demanding. Be creative. Be VIVIX.

A FRESH PERSPECTIVE IN ARCHITECTURAL PANELS *by* FORMICA GROUP







### KRISTIANSAND AIRPORT

PROJECT: air traffic control tower

LOCATION: Kjevik, Norway

DESIGNER: Archus Architects  
and Wiig og Horgmo Architects

MATERIAL: VIVIX® F7912 Storm

APPLICATION: control tower  
cladding

*“VIVIX panels are the ideal solution for this project. The panels are easily machined and can be cut into a variety of shapes and sizes. The control towers are at least 30 metres above ground; the material we used for cladding had to be lightweight for ease of installation and safety as well as versatile and flexible to allow us to realize the design concept.”*

*Roald Bakke  
Architect*





*"VIVIX panels proved ideal thanks to the colour choice, versatility, durability and quality offered."*

*Tor Henrik Sømme  
Architect*







# be INNOVATIVE

VIVIX® architectural panels by Formica Group are solid, lightweight, compact exterior façade panels with a decorative surface on both sides.

An innovative solution composed of thermosetting resins, reinforced with cellulose fibre for its superior strength and durability, enabling the construction of any architectural envelope:

- Office and commercial buildings
  - Hospitals and clinics
  - Schools and Universities
  - Transportation centres
  - Industrial buildings
- Cultural, sports and leisure facilities
  - Residential buildings
  - Hotels



**F0163**  
Fantasía  
Marrón





## ESPAI RIDAURA

PROJECT: multi-purpose facility

LOCATION: Girona, Spain

DESIGNER: Capella García Arquitectura

MATERIAL: VIVIX® F0163 Fantasía Marrón

APPLICATION: building entrance canopy cladding

*“The exceptional feature of this building is its unique entrance with a stunning overhang measuring almost 20 metres. In order to bring this element to life architecturally, we needed to select a material that would be ideal for both interior and exterior applications, being resistant as well as lightweight, given that a bulkier material would challenge the gracefulness of the structure. We decided easily that VIVIX panels met our needs perfectly.”*

*Juli Capella  
Architect*



**F0163**  
Fantasía  
Marrón



# be FUNCTIONAL

The exceptional characteristics of VIVIX® panels make this product a versatile solution, with simple installation and maintenance, improving the look, performance and durability of any building:

- VIVIX panels are resistant to impact and abrasion.
- VIVIX panels are UV and weather resistant and have been rigorously tested for severe use in accordance with EN 438-6&7.
- Available in an array of colours and patterns attuned to contemporary architecture and design.
- VIVIX panels are easily machined and can be cut into a variety of shapes and sizes to express virtually any design concept.
- Panels can be field modified as needed.
- VIVIX panels are easy to maintain and, in most cases, can simply be cleaned with mild detergent and water, in accordance with the Formica Group Use & Care Guide for VIVIX panels.





**F5513**  
Redwood

*"The overall concept was to marry in the rigid form with natural materials using stone and timber. However, the challenge of using timber was the maintenance and durability of the material; we therefore chose VIVIX® panels as they not only exceeded our aesthetics and performance specifications; the maintenance costs have significantly been reduced for the end user."*

*Gavin Veeran*  
*Architect*

**SAINT JAMES'S HOSPITAL**

PROJECT: University teaching hospital

LOCATION: Dublin, Ireland

DESIGNER: Equator Architects Ireland Ltd.

MATERIAL: VIVIX® F5513 Redwood

APPLICATION: façade cladding



# be FRESH

VIVIX® panels offer different types of solutions for façade cladding with a variety of fixing systems:

- simple fixing systems of timber battens
- proprietary metal or aluminum fixing systems with visible face-fixing or by concealed fixing arrangements

The *VENTILATED FAÇADE* is based on an air chamber between the inner structure and the outer cladding skin, allowing continuous ventilation in the interior of the cavity, improving thermal protection and stability.



The building is protected from the effects of atmospheric conditions. During the summer a constant renewal of fresh air prevents overheating of the external walls of the building, preventing rising temperatures inside. In winter, the trend is reversed, avoiding heat loss from the building.





Another key advantage is the *RAINSCREEN PRINCIPLE*. The outer cladding acts as a protective screen against rain and snow. In addition, air that runs through the chamber evaporates moisture, keeping the building dry and insulated, avoiding the adverse effects of moisture on building finishes and structural components.







### LAKUA-ARRIAGA HEALTH CLINIC

PROJECT: health services building

LOCATION: Vitoria-Gasteiz, Spain

DESIGNER: Gerardo Zarrabeitia

MATERIAL: VIVIX® F1238 Carnaval

APPLICATION: façade cladding

*“The health services building consists of two adjoining buildings with a façade of more than 1,000 square metres in total. We chose VIVIX exterior panels for the project because, in addition to being aesthetically attractive, VIVIX panels offered us a number of practical advantages: maximum resistance to impact, moisture, weather and ultraviolet rays, along with carefree maintenance.”*

Gerardo Zarrabeitia  
Architect







*be*  
**DEMANDING**

VIVIX® panels, complying with EN438:2005,  
provide quality solutions for any  
architectural cladding need.

When conditions are demanding  
VIVIX responds with its  
10-year guarantee.







**F2253**  
Diamond  
Black

**F7851**  
Spectrum  
Blue

*Keilaranta office building. Arkton Arkkitehdit Oy. Finland.*





### KEILARANTA 1

PROJECT: eco-efficient office building

LOCATION: Espoo, Finland

DESIGNER: Arkton Arkkitehdit Oy

MATERIAL: VIVIX® F7851 Spectrum Blue  
VIVIX® F2253 Diamond Black

APPLICATION: façade cladding

*“An important starting point in the design of the new Keilaranta 1 building was efficient use of space, offering versatile opportunities. In the implementation of the project, environmental friendliness also played a significant role. Our aim was for the property to reach the LEED® Platinum certification level, which it did. We chose VIVIX for the façade with it being environmentally friendly and reliable as the certifications show.”*

*Matti Karjanoja  
Architect*





**F2253**  
Diamond  
Black

**F7851**  
Spectrum  
Blue

*Keilaranta office building. Arkton Arkkitehdit Oy, Finland.*



# be ECO-FRIENDLY

VIVIX® panels incorporate Formica Group's commitment to sustainable principles and practices. VIVIX panels are manufactured in Europe to ISO 9001 standards with minimal environmental impact as determined by Formica Group's product Life Cycle Assessment (LCA), which tracks the ecological effects of a product throughout its lifespan from raw material procurement, manufacture and transport, to its use, reuse and disposal.

## VIVIX, AN ENVIRONMENTALLY RESPONSIBLE SOLUTION

- Contains 3% of pre-consumer recycled wood fibre content (ISO 14021).
- Wood fibres used in the manufacturing process come from responsibly managed forests.
- All colour pigments are free from heavy metals and solvents.
- Multiple panel sizes optimize yield and minimize fabrication waste.
- When used in rainscreen construction, VIVIX panels can contribute to a building's thermal efficiency.
- May contribute toward optimized building energy performance and moisture regulation.
- Manufacturing plants in Europe are accredited to ISO 14001 environmental management system.
- Formica Group are FSC® certified and comply with the requirements of FSC. Network of participating European Formica Group sites is shown on certificate number TT-COC-003588.
- FSC® certified laminates and compact panels are manufactured in Formica Group's European plants, including VIVIX exterior façade panels.





F3007  
Pale  
Olive



*Prim-Dolaretxe residential buildings. Lázaro, Grijelmo & Asociados. Spain.*



F2510  
Golden  
Morning Oak



Kiddicare. Paul Allan. United Kingdom.



F7967  
Hunter  
Green

Etone College Nuneaton. Alex Collins. United Kingdom.





F2005  
Paprika

*"Apart from the design element VIVIX® provides, it is also an easy to install, competitively priced, high quality product; this made it an ideal choice for the Harthill House project."*

*Richard Peterkin  
Architect*



F7912  
Storm

Asha house - Harthill House Project. BM3 Architecture. United Kingdom.



**F1040**  
Alpino



*Single family dwelling. Kent Johansson. Sweden.*



**F7940**  
Spectrum  
Yellow

*Oriamendi residential buildings. Tanco & Asociados Arquitectura y Urbanismo. Spain.*



F1040  
Alpino



F7912  
Storm



F5513  
Redwood



Oosterbeek-Verpakkinge. Heijneman Bouw. Netherlands.



F2005  
Paprika





**F2726**  
Natural  
Beech

*Social services building. J. González Aristondo & V. Fernández Amezua. Spain.*



# be Younique®

DESIGN A LAMINATE *by* FORMICA GROUP

Create something unique.  
An individualised building,  
reaching as far as the imagination  
of the architect who created it...

**Younique®** by Formica Group  
brings you a one-of-a-kind service,  
offering you the full integration of patterns,  
logos, photographs, or any kind of image  
into the design and build of your projects.

Endless possibilities giving architects  
the peace of mind that with **Younique**,  
customised projects are built to last.







*Transformer Substation Beniferrí-Valencia. Tomás Llavador Arquitectos+Ingenieros.*



*Miribilla residential buildings. IMB Arquitectura.*



# Younique®

DESIGN A LAMINATE by FORMICA GROUP





**Younique**® by Formica Group utilises the latest in print technologies to deliver optimum visual replication of your designs and original artworks.

Access to both digital and silk-screen prints is another advantage provided by Formica Group, allowing for high quality optimisation and the most economical solution on a project-by-project basis.

*DIGITAL PRINTING* is ideal for photographic, detailed or multi-coloured projects or for small run production with no set-up costs and ease of translation from file to print. File transfer is made easy via multiple options for receiving images.

*SILK-SCREEN PRINTING* is ideal for bold, vibrant patterns where specific solid colour references are key (RAL®, Pantone® Matching System or NCS®). Silk-screen printing is cost-effective when the fixed set-up costs are factored out over larger volume production.

All **Younique** projects are priced on volume and complexity. For further information on sizes, pricing quotes, lead-time, file transfer options, etc. go to [www.formica.com](http://www.formica.com) or contact your local Formica Group sales office or representative.



Formica Group exhibition stand at Construmat. Juli Capella & Ramón Cortés.









## FOR ALL TYPES OF APPLICATIONS

*Façades      Fencing*  
*Balconies      Shelters*  
*Soffits      Decorative screening*











*be*  
**CREATIVE**

Plain colours, neutrals or bright tones, abstract designs inspired by nature. New, **TRUE SCALE** decors celebrate the natural beauty of wood in its true form and scale. The *VIVIX*® panels range is developed in collaboration with architects and chromatography consultants to offer the most extensive range of decorative possibilities.

All colours in the *VIVIX* range have undergone rigorous testing to ensure UV stability in accordance with EN 438-2 test methods 28 & 29 for colour fastness and weather resistance. Panels are tested for severe use compliance.



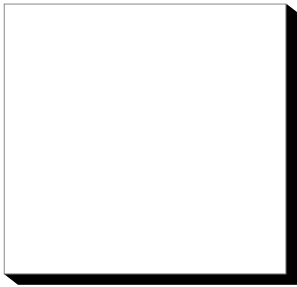

**F0949** Matte 58  
White **NEW**

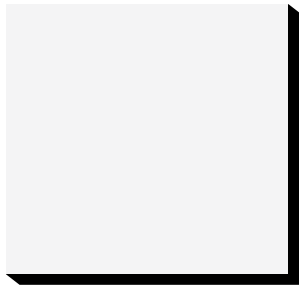

**F2010** Matte 58  
Malibu

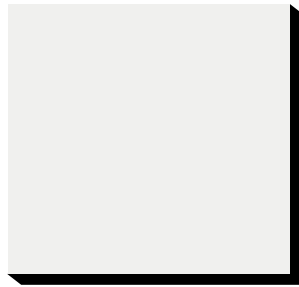

**F2001** Matte 58  
Baikal **NEW**

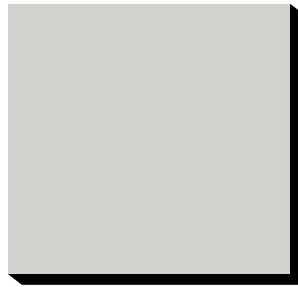

**F7927** Matte 58  
Folkestone

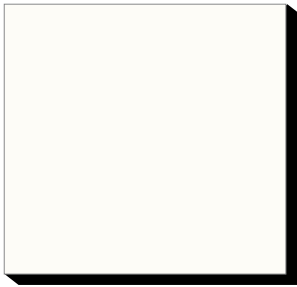

**F1040** Matte 58  
Alpino

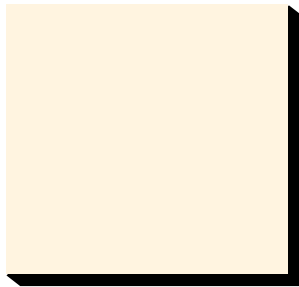

**F1531** Matte 58  
Irish Cream

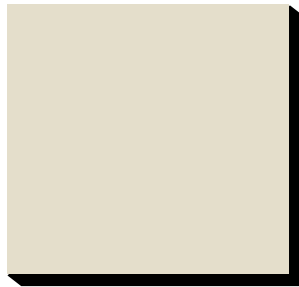

**F7858** Matte 58  
Pumice

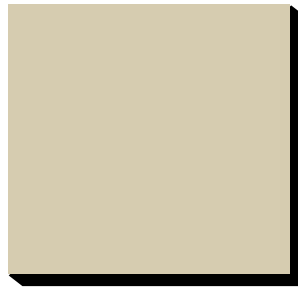

**F2302** Matte 58  
Doeskin



**F1192** Matte 58  
Porcelana **NEW**



**F0901** Matte 58  
Gobi

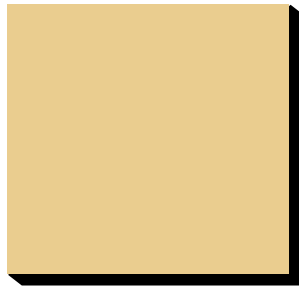

**F1532** Matte 58  
Eldorado

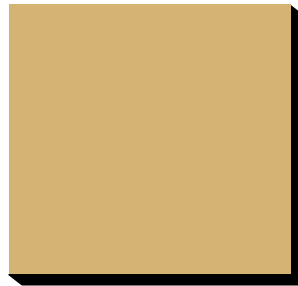

**F0903** Matte 58  
Café



**F2833** Matte 58  
Sandstone



**F8751** Matte 58  
Mojave **NEW**



**F0187** Matte 58  
Kashmir



**F2200** Matte 58  
Dark Chocolate



**F1535** Matte 58  
Tornado



**F7912** Matte 58  
Storm



**F2297** Matte 58  
Terril **NEW**



**F2253** Matte 58  
Diamond Black



# Colors

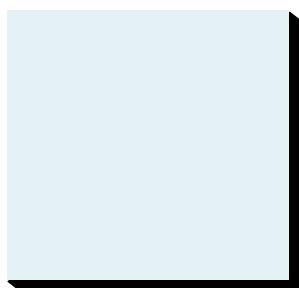

**F5493** Arctic Blue  
Matte 58



**F7884** China Blue  
Matte 58



**F4168** Campanula  
Matte 58 **NEW**



**F7851** Spectrum Blue  
Matte 58

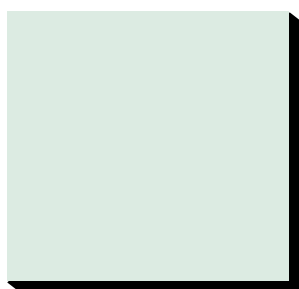

**F5494** Aquamarine  
Matte 58 **NEW**



**F5347** Maui  
Matte 58 **NEW**



**F1998** Oslo  
Matte 58



**F7969** Navy Blue  
Matte 58

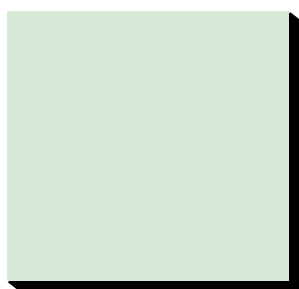

**F2966** Opal  
Matte 58



**F3007** Pale Olive  
Matte 58



**F7853** Ocean Grey  
Matte 58



**F7846** Grotto  
Matte 58 **NEW**



**F2288** Peach  
Matte 58



**F7940** Spectrum Yellow  
Matte 58



**F6901** Vibrant Green  
Matte 58



**F7967** Hunter Green  
Matte 58



**F4161** Terracotta  
Matte 58



**F1238** Carnival  
Matte 58



**F2005** Paprika  
Matte 58





**F3735**  
Krypton

Matte 58



**F6074**  
Millsawn Slate

Matte 58  
**NEW**  
TRUE SCALE

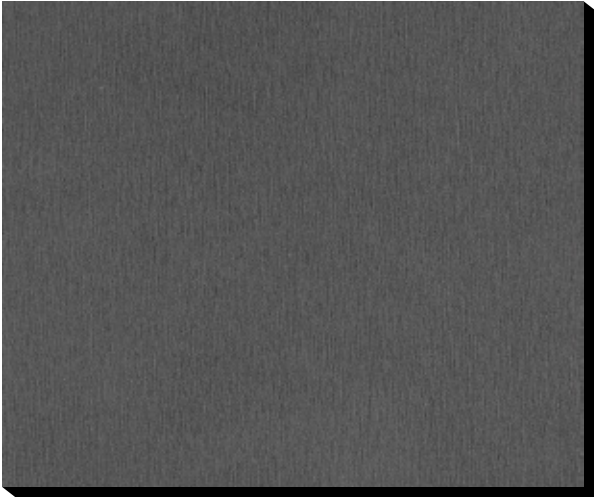

**F3734**  
Radon

Matte 58

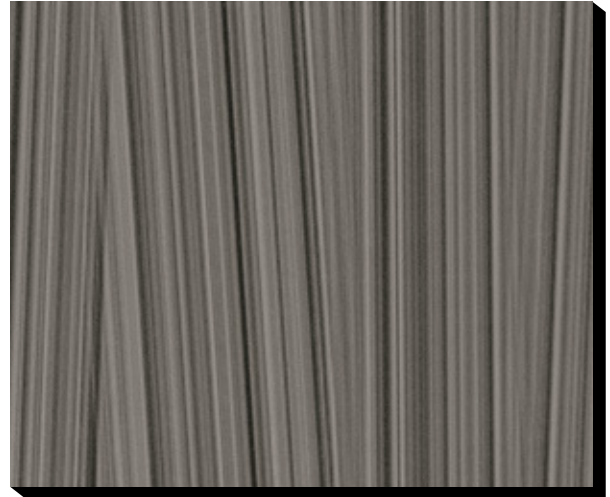

**F6068**  
Shadow Strié

Matte 58  
**NEW**  
TRUE SCALE



**F6067**  
Steel Materia

Matte 58  
**NEW**  
TRUE SCALE



**F6064**  
Oxide Materia

Matte 58  
**NEW**  
TRUE SCALE





**F6071**  
Millsawn Stone

Matte 58  
**NEW**  
TRUE SCALE



**F1155**  
Marrón

Matte 58



**F6069**  
Delta Strié

Matte 58  
**NEW**  
TRUE SCALE



**F0163**  
Fantasía Marrón

Matte 58



**F6063**  
Rust Materia

Matte 58  
**NEW**  
TRUE SCALE



**F6065**  
Bronze Materia

Matte 58  
**NEW**  
TRUE SCALE



**F3855**  
Clear Maple

Matte 58



**F5530**  
Savoy Beech

Matte 58



**F2510**  
Golden Morning Oak

Matte 58



**F5532**  
Erable Whisky

Matte 58



**F5511**  
Vosges Pear

Matte 58



**F6060**  
Marron Cumaru

Matte 58  
**NEW**  
TRUE SCALE



**F6059**  
Sienna Cumaru

Matte 58  
**NEW**  
TRUE SCALE



**F5513**  
Redwood

Matte 58

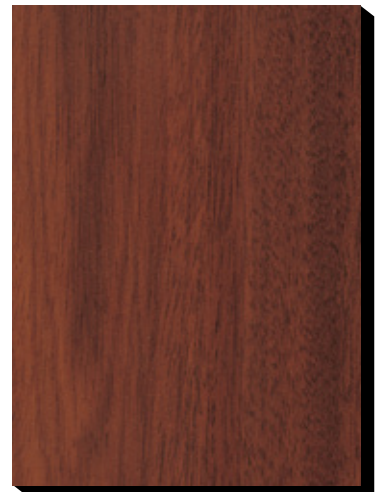

**F0905**  
Mahogany

Matte 58





**F6053**  
Chalet Oak

Matte 58  
**NEW**  
TRUE SCALE



**F6052**  
Cottage Oak

Matte 58  
**NEW**  
TRUE SCALE



**F6058**  
Bark Microplank

Matte 58  
**NEW**  
TRUE SCALE



**F6050**  
Barn Oak

Matte 58  
**NEW**  
TRUE SCALE



**F5488**  
Smoky Brown Pear

Matte 58



**F6057**  
Ash Microplank

Matte 58  
**NEW**  
TRUE SCALE



**F6051**  
Mission Oak

Matte 58  
**NEW**  
TRUE SCALE

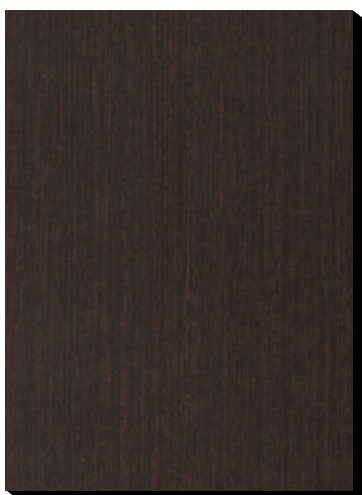

**F1614**  
Punga Punga Wood

Matte 58

VIVIX® by Formica Group offers you **TRUE SCALE**, the next generation of decorative surfacing represented in the real scale of natural timber and other materials, depicting the patterns, striking veining and rich colour variations of each material across the width of the VIVIX panel.

In exterior, large-scale applications, **TRUE SCALE** gives you the effect of endless wood grain or the visual richness of aged metals, avoiding the repetition of smaller patterns in more conventional decorative surfaces. With **TRUE SCALE** enjoy all the practical advantages of robust architectural panels with the exclusive look and scale of real materials, without the associated expense and maintenance issues.



**F3855** Clear Maple



**F5530** Savoy Beech



**F2510** Golden Morning Oak

*Woodgrain structures are offered for visualization of panels in their full dimensions. Full size sheets are available in 3050 x 1300 mm and are shown here at approximately 1:26 and 1:12 scales.*

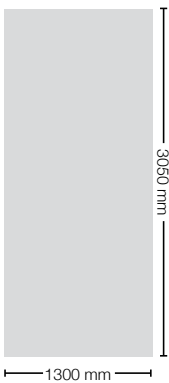

**F5532** Erable Whisky



**F5511** Vosges Pear



# Woodgrain structures



**F6059** Sienna Cumaru

**NEW**  
TRUE SCALE



**F5513** Redwood

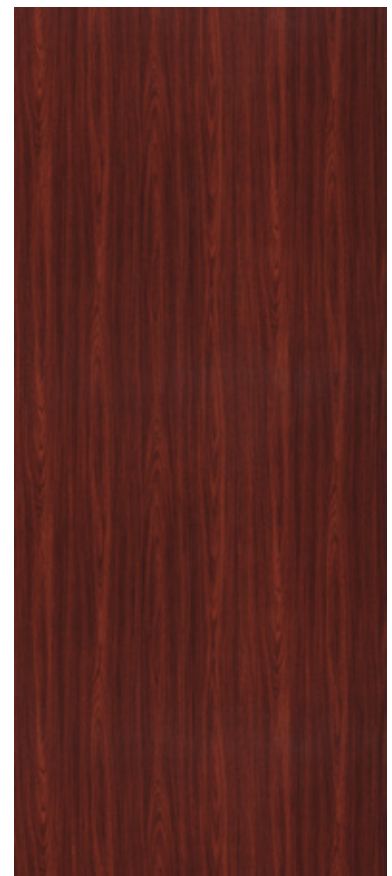

**F0905** Mahogany



F6050 Barn Oak **NEW**  
TRUE SCALE



F6053 Chalet Oak **NEW**  
TRUE SCALE



F6052 Cottage Oak **NEW**  
TRUE SCALE



F6060 Marron Cumaru **NEW**  
TRUE SCALE



F6051 Mission Oak **NEW**  
TRUE SCALE



F5488 Smoky Brown Pear



# Woodgrain structures



F6058 Bark Microplank

**NEW**  
TRUE SCALE



F6057 Ash Microplank











**NEW**  
TRUE SCALE



F1614 Punga Punga Wood

	Code	Name	Range	NCS®	RAL®	Finish
	F0163	Fantasia Marrón	Patterns			Matte 58
	F0187	Kashmir	Colors	S 5010-Y30R		Matte 58
	F0901	Gobi	Colors	S 1010-Y30R		Matte 58
	F0903	Café	Colors	S 3020-Y20R		Matte 58
	F0905	Mahogany	Woods			Matte 58
	F0949	White	Colors	S 0502-R50B		Matte 58
	F1040	Alpino	Colors	S 0502-G50Y	9010	Matte 58
	F1155	Marrón	Patterns			Matte 58
	F1192	Porcelana	Colors	S 0505-Y20R	1013	Matte 58
	F1238	Carnaval	Colors	S 1580-Y90R	3001	Matte 58
	F1531	Irish Cream	Colors	S 1005-Y50R		Matte 58
	F1532	Eldorado	Colors	S 1020-Y20R	1014	Matte 58
	F1535	Tornado	Colors	S 4500-N	7036	Matte 58
	F1614	Punga Punga Wood	Woods			Matte 58
	F1998	Oslo	Colors	S 3020-B		Matte 58
	F2001	Baikal	Colors	S 1502-Y	9002	Matte 58
	F2005	Paprika	Colors	S 4050-Y80R		Matte 58
	F2010	Malibu	Colors	S 1000-N		Matte 58
	F2200	Dark Chocolate	Colors	S 8005-Y80R	8017	Matte 58
	F2253	Diamond Black	Colors	S 9000-N	9011	Matte 58
	F2288	Peach	Colors	S 1515-Y40R		Matte 58
	F2297	Terril	Colors	S 7502-B	7016	Matte 58
	F2302	Doeskin	Colors	S 2010-Y		Matte 58
	F2510	Golden Morning Oak	Woods			Matte 58
	F2833	Sandstone	Colors	S 2010-Y30R		Matte 58
	F2966	Opal	Colors	S 1010-G10Y		Matte 58
	F3007	Pale Olive	Colors	S 3020-G60Y		Matte 58
	F3734	Radon	Patterns			Matte 58
	F3735	Krypton	Patterns			Matte 58
	F3855	Clear Maple	Woods			Matte 58
	F4161	Terracotta	Colors	S 3040-Y60R		Matte 58
	F4168	Campanula	Colors	S 1550-R80B		Matte 58
	F5347	Maui	Colors	S 2030-B30G		Matte 58
	F5488	Smoky Brown Pear	Woods			Matte 58
	F5493	Arctic Blue	Colors	S 0510-R90B		Matte 58
	F5494	Aquamarine	Colors	S 0510-B90G		Matte 58
	F5511	Vosges Pear	Woods			Matte 58
	F5513	Redwood	Woods			Matte 58
	F5530	Savoy Beech	Woods			Matte 58
	F5532	Erable Whisky	Woods			Matte 58
	F6050	Barn Oak	Woods			Matte 58
	F6051	Mission Oak	Woods			Matte 58
	F6052	Cottage Oak	Woods			Matte 58
	F6053	Chalet Oak	Woods			Matte 58
	F6057	Ash Microplank	Woods			Matte 58
	F6058	Bark Microplank	Woods			Matte 58
	F6059	Sienna Cumaru	Woods			Matte 58
	F6060	Marron Cumaru	Woods			Matte 58
	F6063	Rust Materia	Patterns			Matte 58
	F6064	Oxide Materia	Patterns			Matte 58
	F6065	Bronze Materia	Patterns			Matte 58
	F6067	Steel Materia	Patterns			Matte 58
	F6068	Shadow Strié	Patterns			Matte 58
	F6069	Delta Strié	Patterns			Matte 58
	F6071	Millsawn Stone	Patterns			Matte 58
	F6074	Millsawn Slate	Patterns			Matte 58
	F6901	Vibrant Green	Colors	S 2060-G30Y	6018	Matte 58



	Code	Name	Range	NCS®	RAL®	Finish
	F7846	Grotto	Colors	S 5030-B10G		Matte 58
	F7851	Spectrum Blue	Colors	S 3060-R80B		Matte 58
	F7853	Ocean Grey	Colors	S 3010-G20Y		Matte 58
	F7858	Pumice	Colors	S 2005-Y20R		Matte 58
	F7884	China Blue	Colors	S 3020-R90B		Matte 58
	F7912	Storm	Colors	S 6502-B	7015	Matte 58
	F7927	Folkestone	Colors	S 2500-N		Matte 58
	F7940	Spectrum Yellow	Colors	S 1070-Y10R	1023	Matte 58
	F7967	Hunter Green	Colors	S 7020-G	6005	Matte 58
	F7969	Navy Blue	Colors	S 7020-R80B	5013	Matte 58
	F8751	Mojave	Colors	S 3010-Y30R		Matte 58

Panel Sizes (mm)
2150 x 950
2150 x 1300
2440 x 1300
3050 x 1300
3660 x 1525

Grades (EN 438-6)
EDS <i>Exterior grade, severe use, standard grade.</i>
EDF <i>Exterior grade, severe use, flame-retardant grade B-s1,d0.</i>

Thicknesses (mm)
4.5
6.0
8.0
10.0



Please note that colour systems and their notations represent the closest colour available in the particular colour system and are provided for guidance only.

## CERTIFICATES

- Avis Technique (Technical Opinion) N° 2/03-984-985, Centre Scientifique et Technique du Bâtiment (CSTB).
- Document for Technical Suitability (DIT), Eduardo Torroja.
- Euroclass B-s1,d0 (EDF ≥ 6mm) Fire Retardant Certificate in accordance with European regulation EN 13501-1.
- VIVIX® panels are certified by the CE Mark to meet or exceed conformity with European consumer safety, health and environmental requirements.
- Certificate N° E203388 for Quality Management Systems, (ISO 9001:2000), Lloyd's Register Quality Assurance Limited.
- Formica Group are FSC® certified and comply with the requirements of FSC. Network of participating European Formica Group sites is shown on certificate number TT-COC-003588.



EN438-6



BYGGVARUBEDÖMNINGEN



Please note, not all sizes of panel are available with all certifications.

Designs given in this publication have been matched as closely as printing conditions allow. We do recommend, however, that you order samples before final specification, fabrication or installation, as the colour samples in the brochure may differ in shade, hue, tone or brightness to the products purchased.

## Product description

VIVIX® solid phenolic, engineered exterior façade panels have a decorative surface on both sides. Robust and resilient, these rigid homogeneous panels are manufactured by Formica Group, using tough thermosetting resins reinforced with cellulose fibre for added strength and durability.

An acrylic overlay provides enhanced UV protection and VIVIX panels have been rigorously tested for severe use in accordance with EN 438-6, making them ideal for applications in ventilated rainscreen façades and other external building elements.

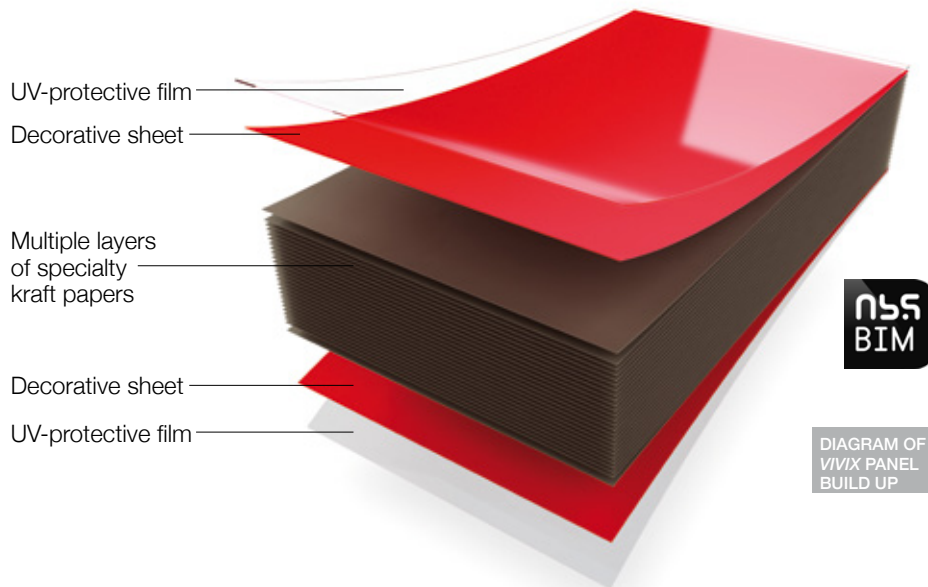

## VIVIX architectural panels for ventilated rainscreen façades and other external building elements

Ventilated rainscreen façades with VIVIX panels are made up of the following elements:

- VIVIX panel in EDS or EDF grade
- Air cavity
- Thermal insulation
- Substructure, which transmits load to the structural wall
- Elements that attach panels to the substructure

VIVIX panel features and benefits:

- Broad range of decorative panels
- Optimal modulation using different sized panels
- UV resistant
- Durability
- Weather resistant
- Impact resistant
- VIVIX panels do not rot and are highly resilient against cracking
- Mechanical and chemical properties unchanged in testing at 180 °C
- Meets Fire Safety Standards. Does not melt or drip
- Easy to clean and maintain
- Dimensional stability and flatness
- Lightweight
- Low static electricity, does not attract dust
- Quick and easy to assemble
- Minimal maintenance
- No thermal bridge
- Limits heat loss in winter and the transmission of heat in summertime
- Overall lightweight substructure and façade

*All features and benefits are subject to fair wear and tear and wilful damage, misuse or negligence by the buyer or user.*

*UV and weather resistance cannot be confirmed where the panels are located in places with climatic sunlight energy conditions exceeding those in EN 438-2, test methods 28 & 29.*

*These drawings indicate typical fixing arrangements on various supporting structures. Please contact your Formica Group representative for other possibilities. Any information or suggestions concerning applications, specification or compliance with regulations and standards is provided solely for your convenient reference and without any representation as to accuracy or suitability. The user must verify and test the suitability of any information or products for his or her particular purpose or specific application.*

*Technical drawings in this brochure should be considered as general examples of how VIVIX panels can be installed, there are other profiles and systems available in the market for ventilated façades which are not shown in this brochure. Consideration needs to be given to local circumstances, for example climate, wind load and local building regulations.*



## RAINSCREEN SYSTEM IN DETAIL WITH VISIBLE ATTACHMENTS

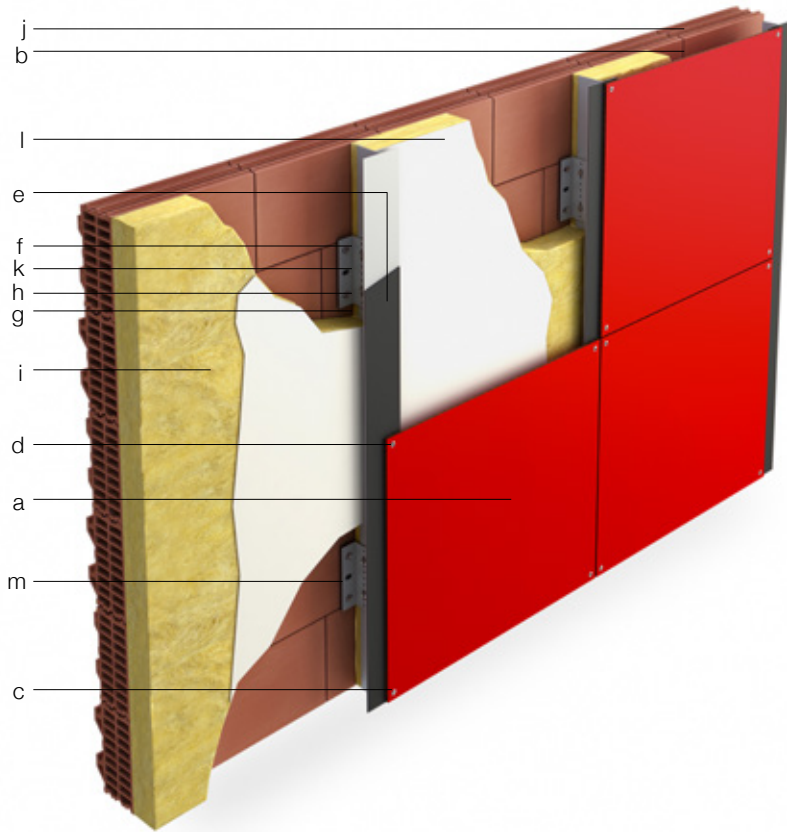

- a VIVIX® panel thickness: 6, 8 or 10 mm
- b Air cavity: 20 mm (min.)
- c Hole diameter: 1.5 x screw / rivet diameter
- d Rivet
- e EPDM rubber strip
- f Vertical fixing profile
- g Stainless steel screw
- h Fixing bracket
- i Thermal insulation
- j Load bearing wall
- k Bridge bearing rubber pads
- l Weather resistive barrier
- m Anchor bolt / screw

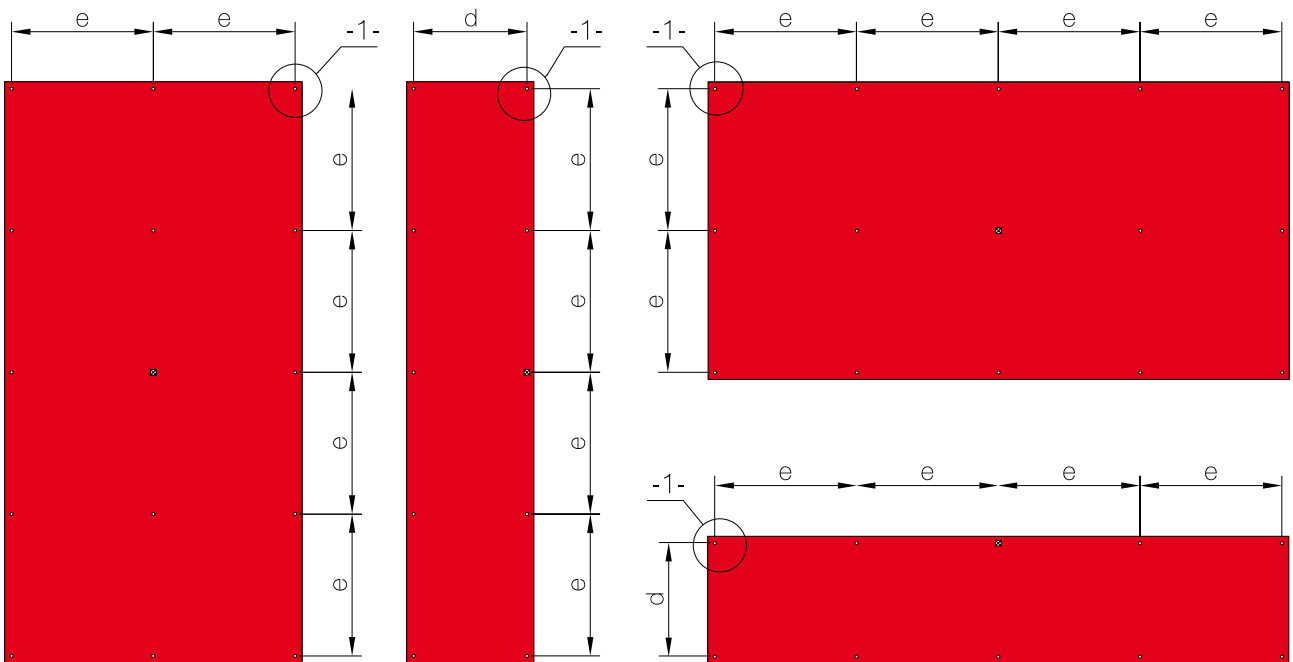

∅ Fixed point: 1 x screw / rivet diameter (typically 5 mm)

Scale 1:40

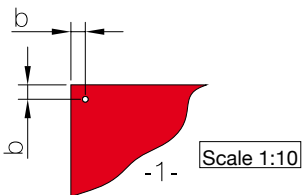

Scale 1:10

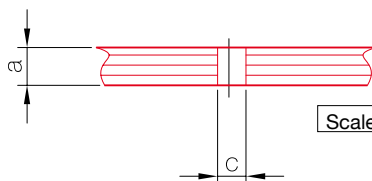

Scale 1:2

- a VIVIX panel thickness: 6, 8 or 10 mm
- b Typical edge distance: min 20 mm - max see table on right
- c Hole diameter: 1.5 x screw / rivet diameter
- d Spacing: 450 mm, 600 mm, 750 mm (2 fixings in one direction)
- e Spacing: 600 mm, 750 mm, 900 mm (3 or more fixings in one direction)

	b	d	e
VIVIX panel thickness: 6 mm	60 mm (max)	450 mm	600 mm
VIVIX panel thickness: 8 mm	80 mm (max)	600 mm	750 mm
VIVIX panel thickness: 10 mm	100 mm (max)	750 mm	900 mm

RAINSCREEN SYSTEM IN DETAIL WITH CONCEALED ATTACHMENTS

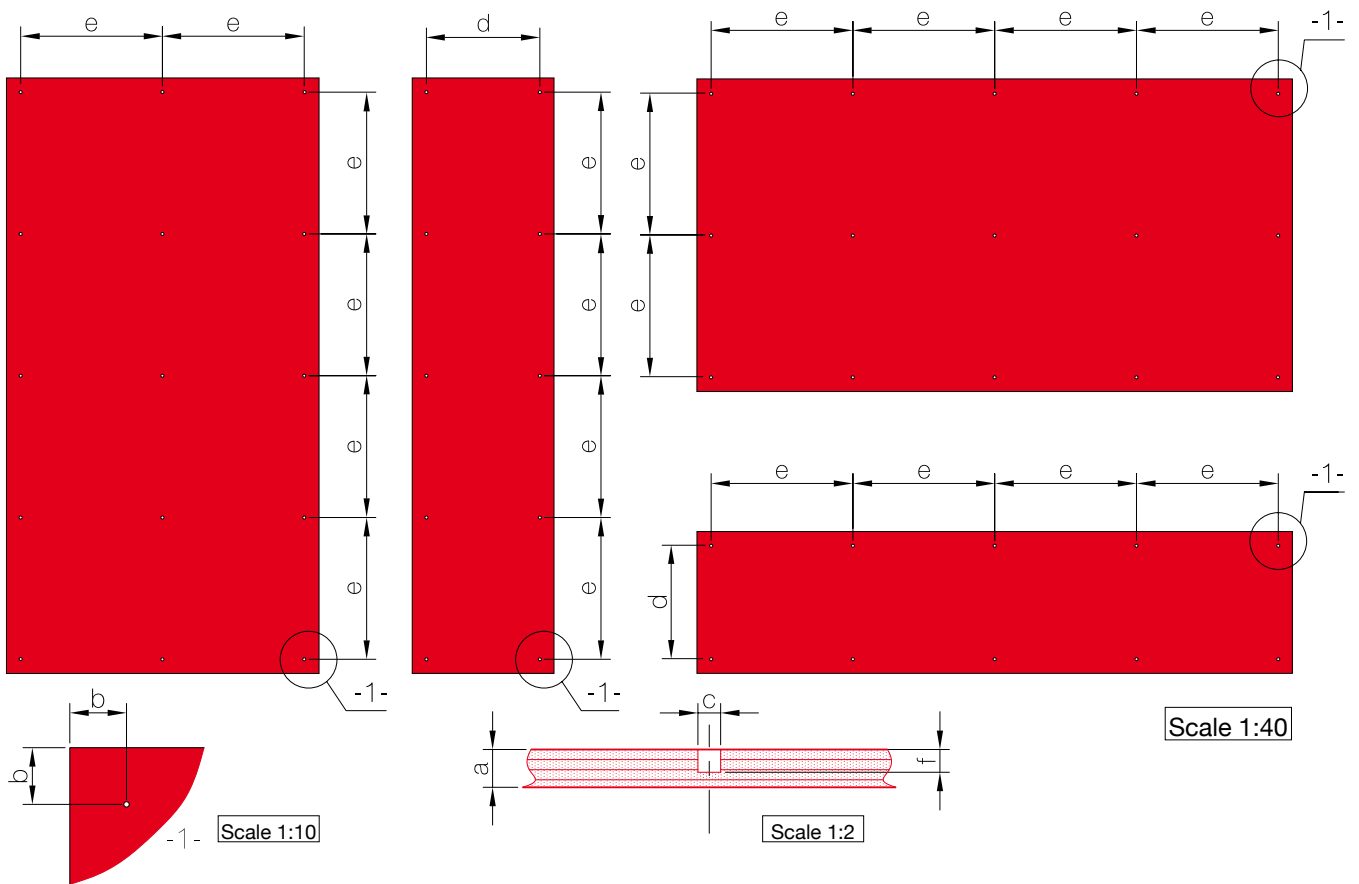
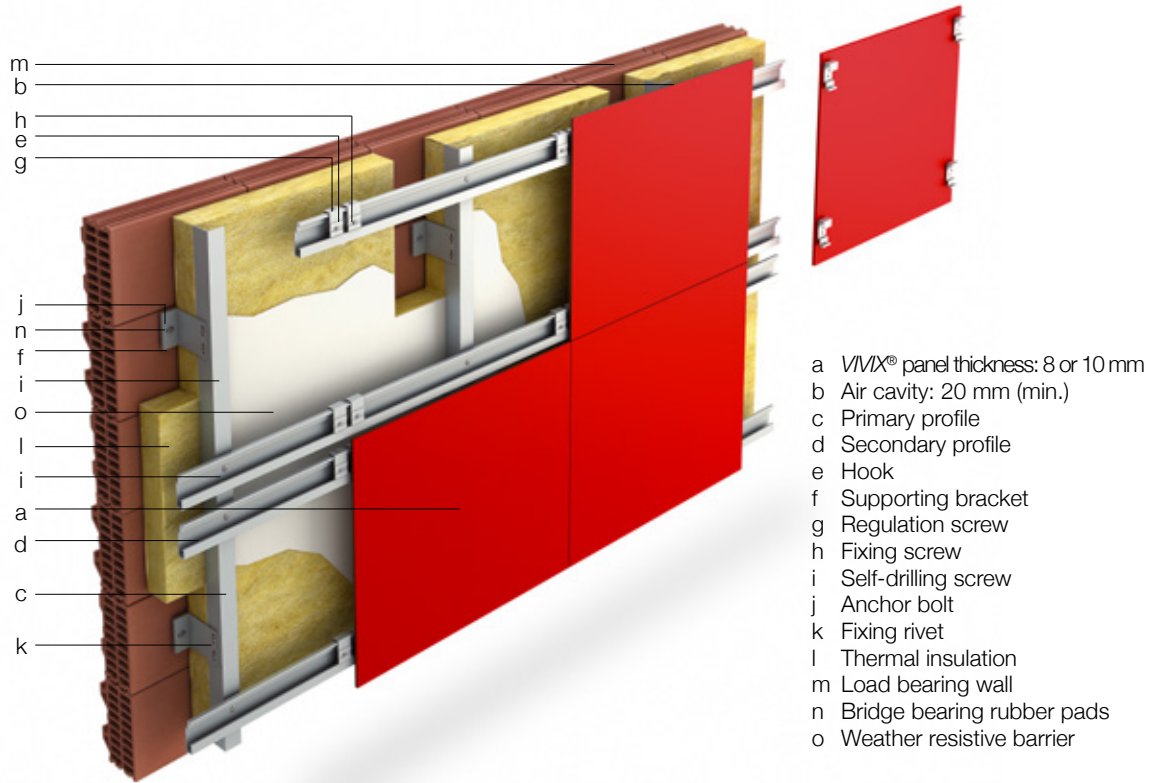

- a VIVIX panel thickness: 8 or 10 mm  
 b Min 75 mm - max see table on right  
 c Diameter to suit fixing screw  
 d Spacing: 600 mm, 750 mm (2 fixings in one direction)  
 e Spacing: 750 mm, 900 mm (3 or more fixings in one direction)  
 f Fixing screw depth: 6 mm

	b	d	e
VIVIX panel thickness: 8 mm	80 mm (max)	600 mm	750 mm
VIVIX panel thickness: 10 mm	100 mm (max)	750 mm	900 mm



**RAINSCREEN SYSTEM IN DETAIL WITH VISIBLE ATTACHMENTS ON WOODEN SUBSTRUCTURE**

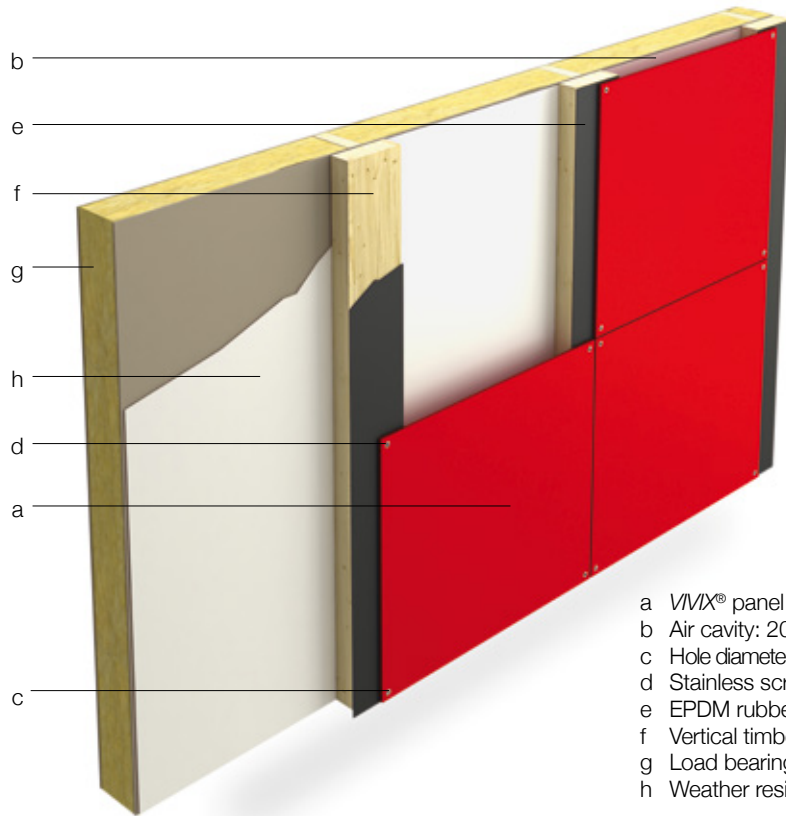

- a VIVIX® panel thickness: 6, 8 or 10 mm
- b Air cavity: 20 mm (min.)
- c Hole diameter: 1.5 x screw / rivet diameter
- d Stainless screw
- e EPDM rubber strip
- f Vertical timber batten
- g Load bearing wall
- h Weather resistive barrier

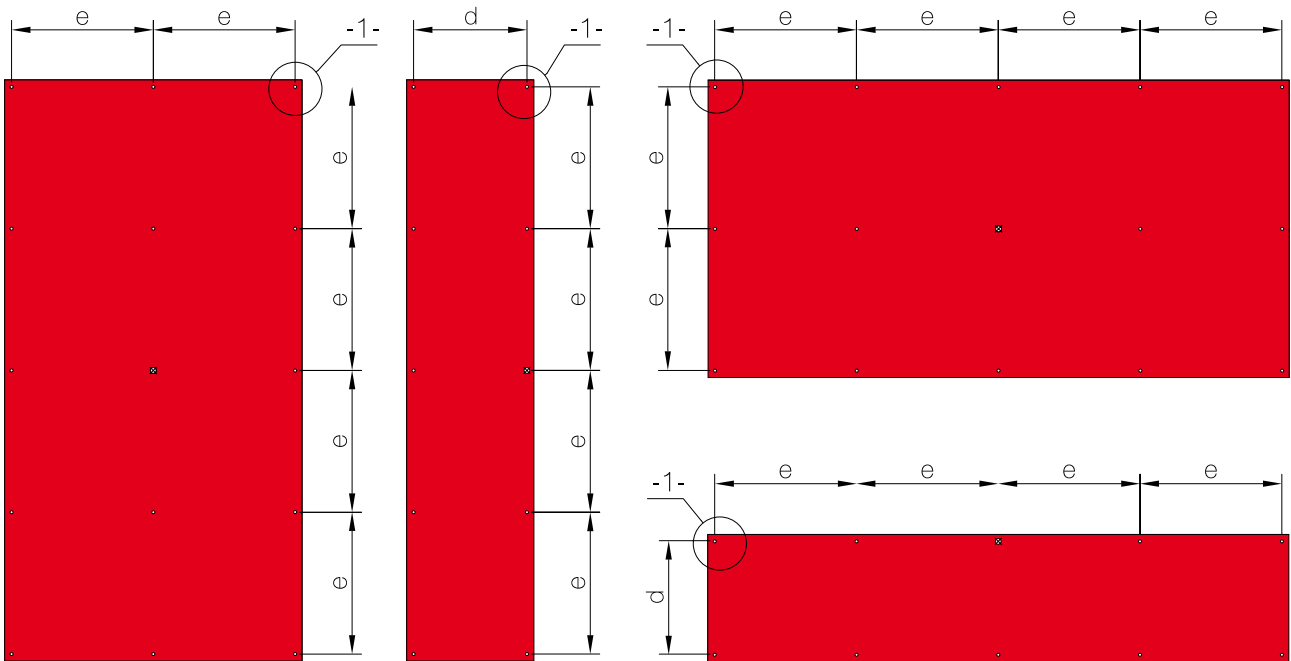

Fixed point: 1 x screw / rivet diameter (typically 5 mm)

**Scale 1:40**

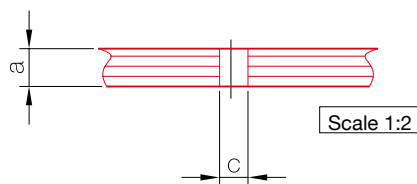
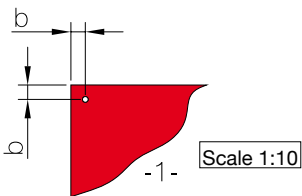

- a VIVIX panel thickness: 6, 8 or 10 mm
- b Typical edge distance: min 20 mm - max see table on right
- c Hole diameter: 1.5 x screw / rivet diameter
- d Spacing: 450 mm, 600 mm, 750 mm (2 fixings in one direction)
- e Spacing: 600 mm, 750 mm, 900 mm (3 or more fixings in one direction)

	b	d	e
VIVIX panel thickness: 6 mm	60 mm (max)	450 mm	600 mm
VIVIX panel thickness: 8 mm	80 mm (max)	600 mm	750 mm
VIVIX panel thickness: 10 mm	100 mm (max)	750 mm	900 mm

## Construction details

### Metal substructure

#### Visible attachment

#### Horizontal cross-section

VIVIX® panels can be attached to a metal profile using rivets, screws and concealed attachments.

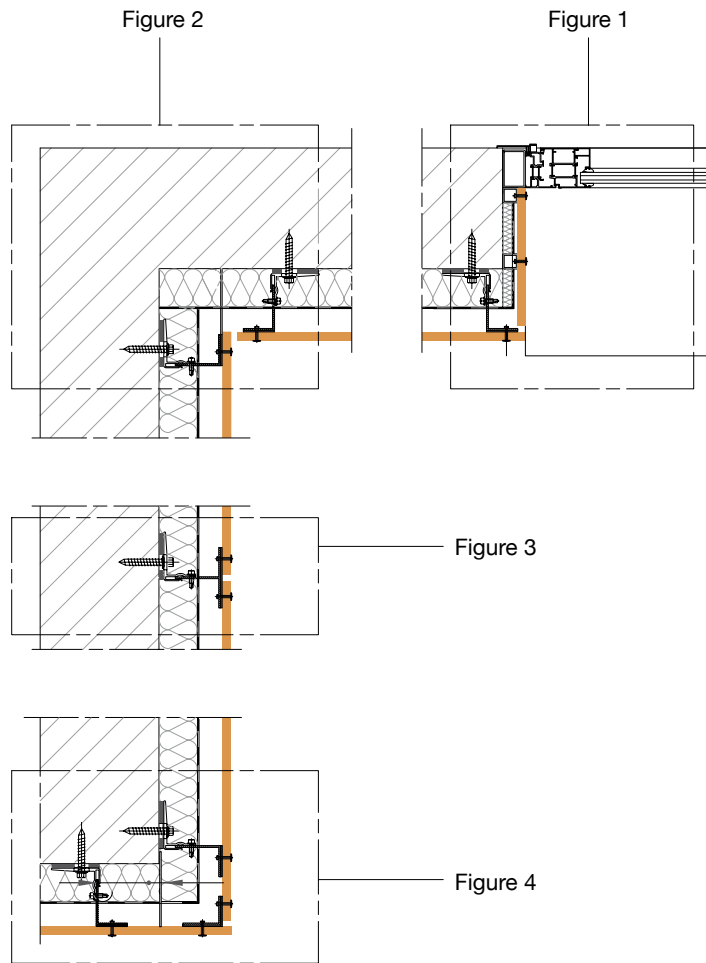

Scale 1:10

*This drawing indicates a typical fixing arrangement on a metal supporting structure. Please contact your Formica Group representative for other possibilities. Any information or suggestions concerning applications, specification or compliance with regulations and standards is provided solely for your convenient reference and without any representation as to accuracy or suitability. The user must verify and test the suitability of any information or products for his or her particular purpose or specific application.*

*Technical drawings in this brochure should be considered as general examples of how VIVIX panels can be installed, there are other profiles and systems available in the market for ventilated façades which are not shown in this brochure. Consideration needs to be given to local circumstances, for example climate, wind load and local building regulations.*



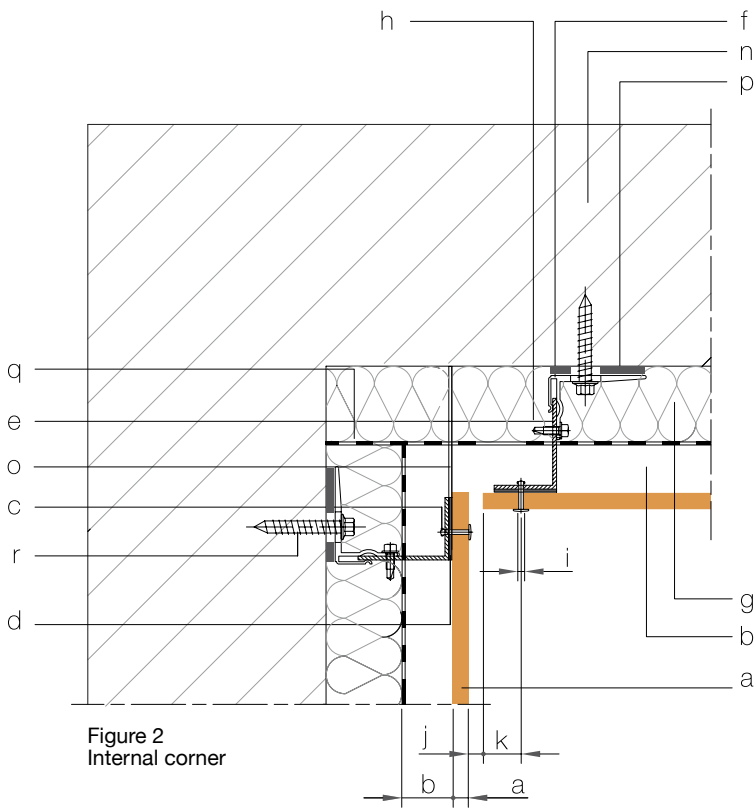

Figure 2  
Internal corner

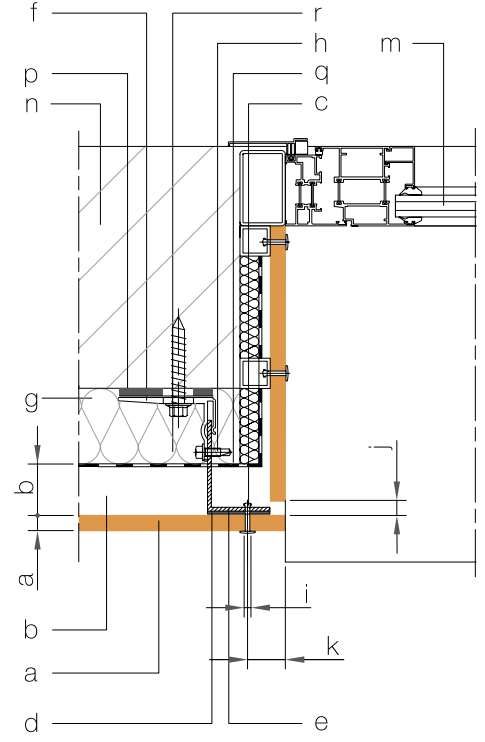

Figure 1  
Window detail

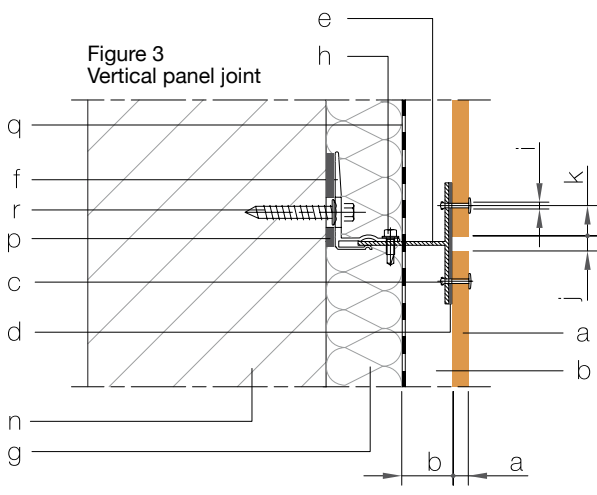

Figure 3  
Vertical panel joint

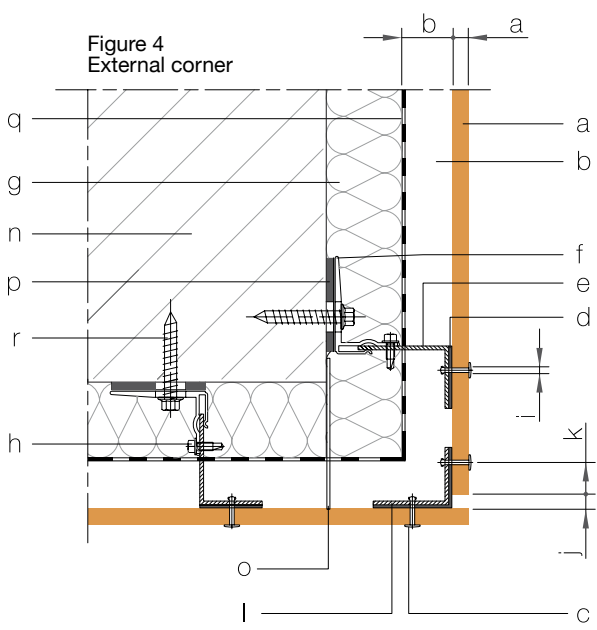

Figure 4  
External corner

Scale 1:5

- a VIVIX® panel thickness: 6, 8 or 10 mm
- b Air cavity: 20 mm (min.)
- c Fixing rivet
- d EPDM rubber strip
- e Vertical fixing profile (L or T)
- f Fixing bracket
- g Thermal insulation
- h Stainless steel screw
- i Hole diameter: 1.5 x fixing rivet diameter
- j Min. joint dimension: 10 mm
- k Edge distance: min. 20 mm - max. 10 x panel thickness
- l Vertical profile "L"
- m Window
- n Load bearing wall
- o Aluminium plate (air cavity interruption)
- p Bridge bearing rubber pads
- q Weather resistive barrier
- r Anchor bolt / screw

**Construction details**  
**Metal substructure**  
**Visible attachment**  
**Vertical cross-section**

Scale 1:10

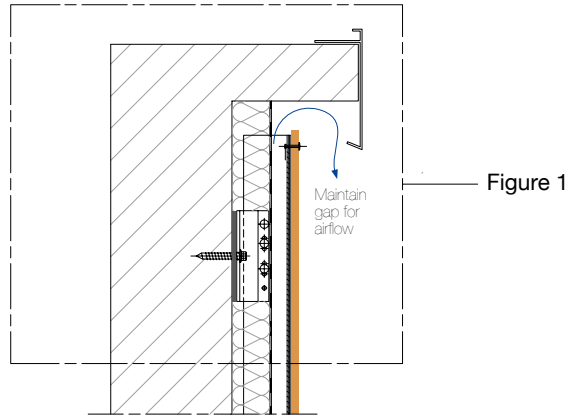

Figure 1

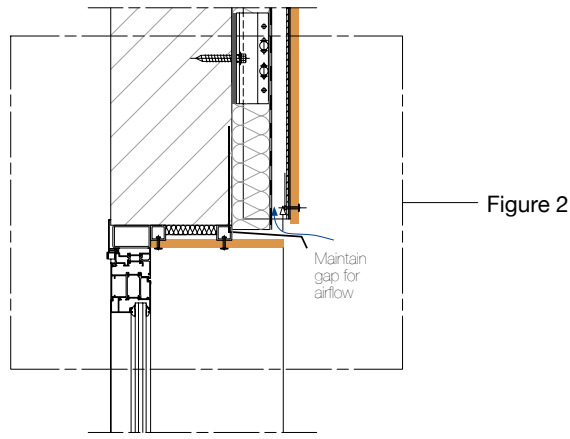

Figure 2

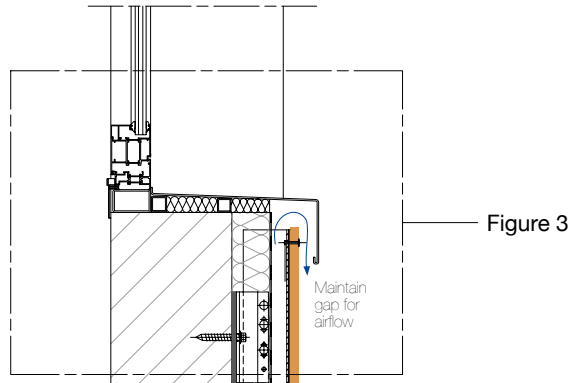

Figure 3

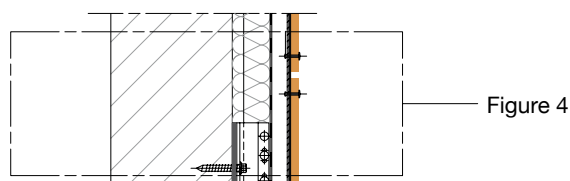

Figure 4

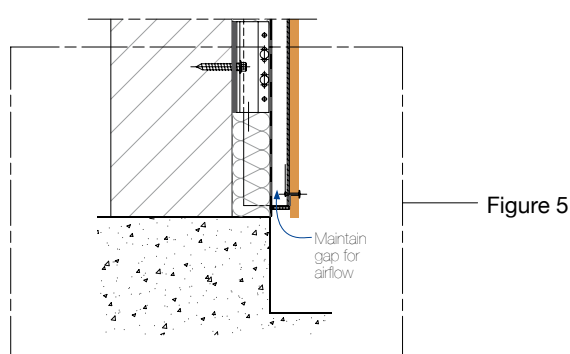

Figure 5

*This drawing indicates a typical fixing arrangement on a metal supporting structure. Please contact your Formica Group representative for other possibilities. Any information or suggestions concerning applications, specification or compliance with regulations and standards is provided solely for your convenient reference and without any representation as to accuracy or suitability. The user must verify and test the suitability of any information or products for his or her particular purpose or specific application.*

*Technical drawings in this brochure should be considered as general examples of how VIVIX® panels can be installed, there are other profiles and systems available in the market for ventilated façades which are not shown in this brochure. Consideration needs to be given to local circumstances, for example climate, wind load and local building regulations.*



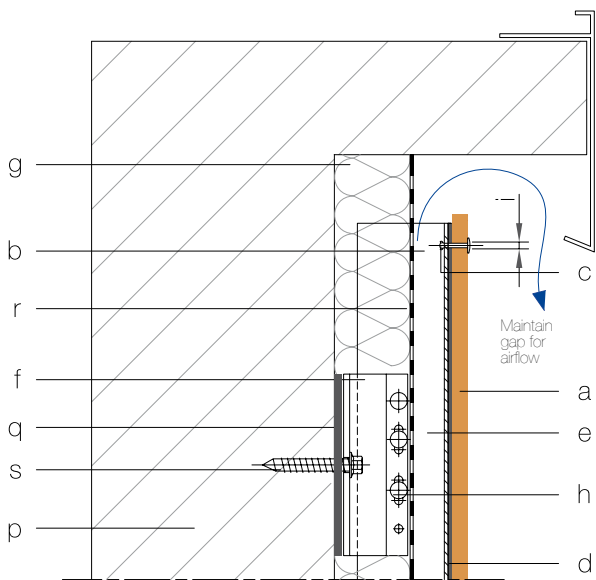

Figure 1  
Top of wall

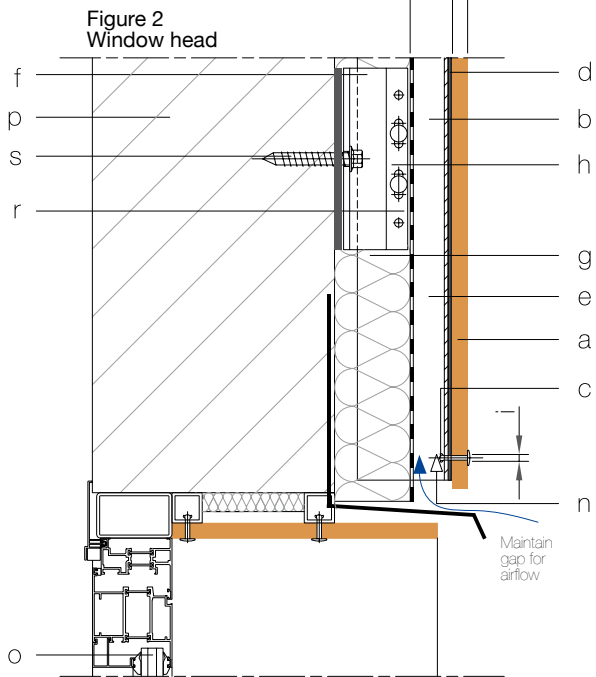

Figure 2  
Window head

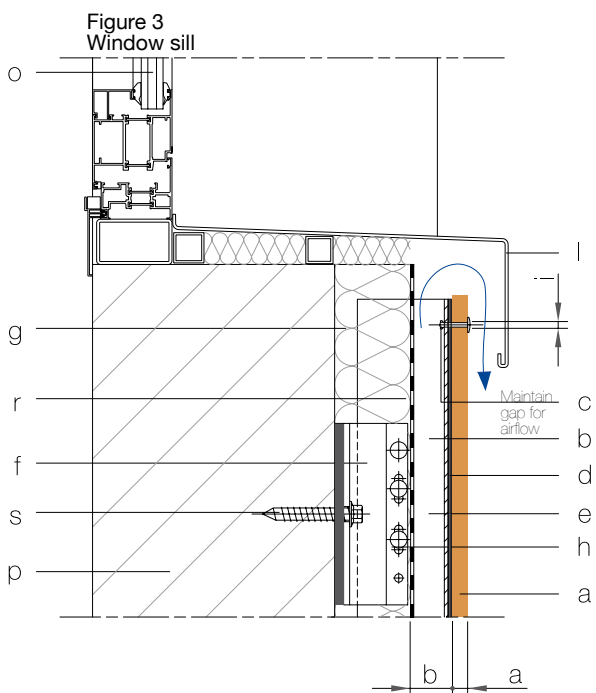

Figure 3  
Window sill

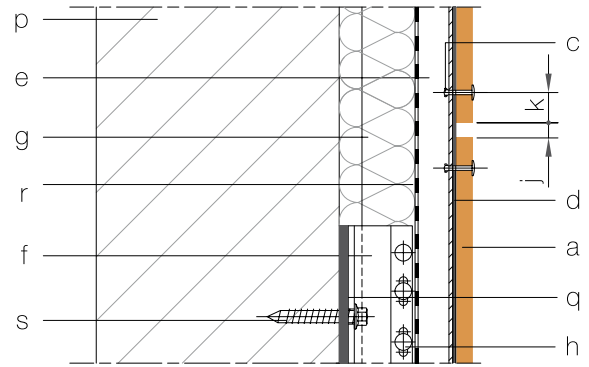

Figure 4  
Horizontal panel joint

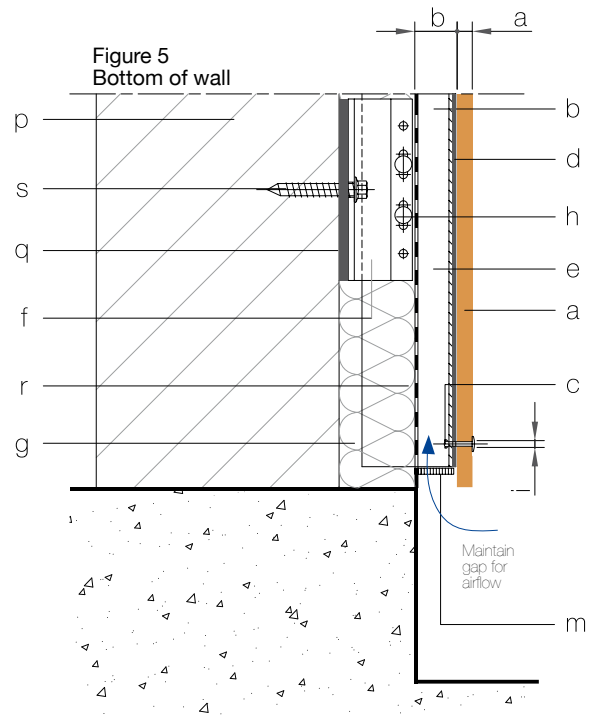

Figure 5  
Bottom of wall

**Scale 1:5**

- a VVIX® panel thickness: 6, 8 or 10 mm
- b Air cavity: 20 mm (min.)
- c Fixing rivet
- d EPDM rubber strip
- e Vertical fixing profile (L or T)
- f Fixing bracket
- g Thermal insulation
- h Stainless steel screw
- i Hole diameter: 1.5 x fixing rivet diameter
- j Min. joint dimension: 10 mm
- k Edge distance: min. 20 mm - max. 10 x panel thickness
- l Formed metal sheet
- m Ventilation grille
- n Ventilation area: 50 cm<sup>2</sup>/m (min.)
- o Window
- p Load bearing wall
- q Bridge bearing rubber pads
- r Weather resistive barrier
- s Anchor bolt / screw

**Construction details**

**Metal substructure**

Concealed metal attachment

Horizontal cross-section

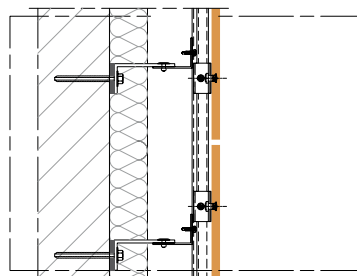
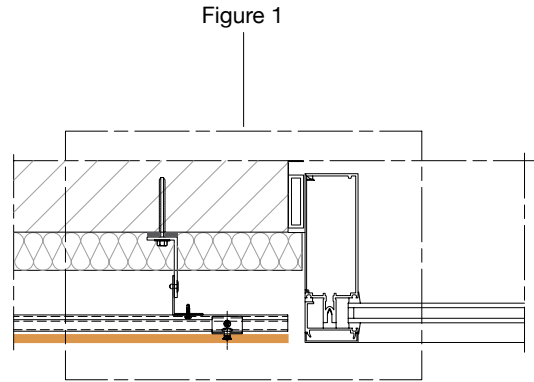
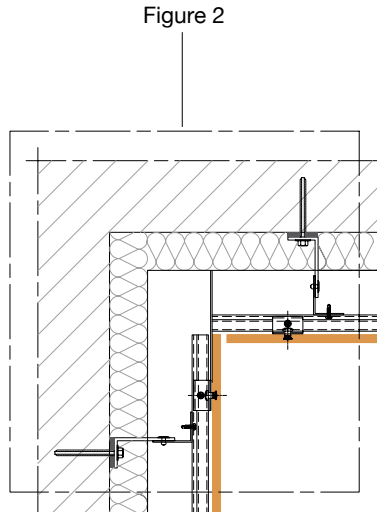

Figure 3

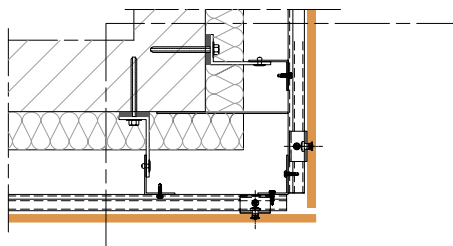

Figure 4

Scale 1:10

*This drawing indicates a typical fixing arrangement on a metal supporting structure. Please contact your Formica Group representative for other possibilities. Any information or suggestions concerning applications, specification or compliance with regulations and standards is provided solely for your convenient reference and without any representation as to accuracy or suitability. The user must verify and test the suitability of any information or products for his or her particular purpose or specific application.*

*Technical drawings in this brochure should be considered as general examples of how VIVIX® panels can be installed, there are other profiles and systems available in the market for ventilated façades which are not shown in this brochure. Consideration needs to be given to local circumstances, for example climate, wind load and local building regulations.*



Figure 2  
Internal corner

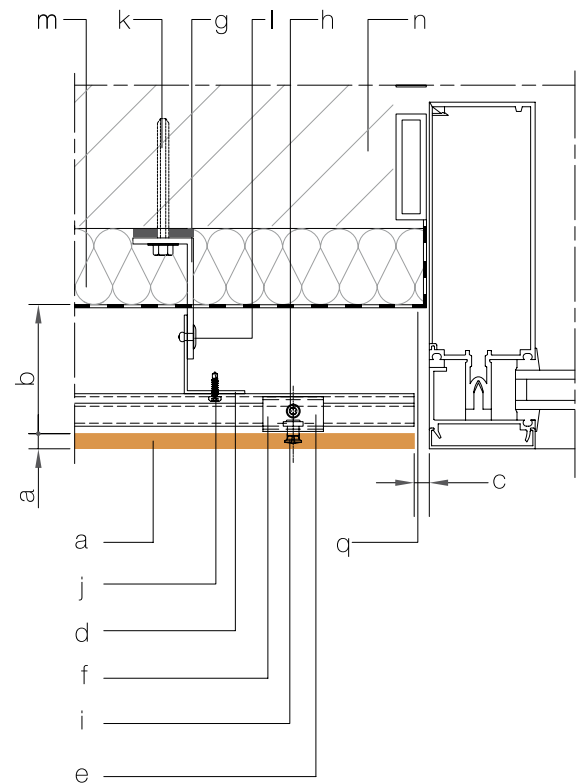
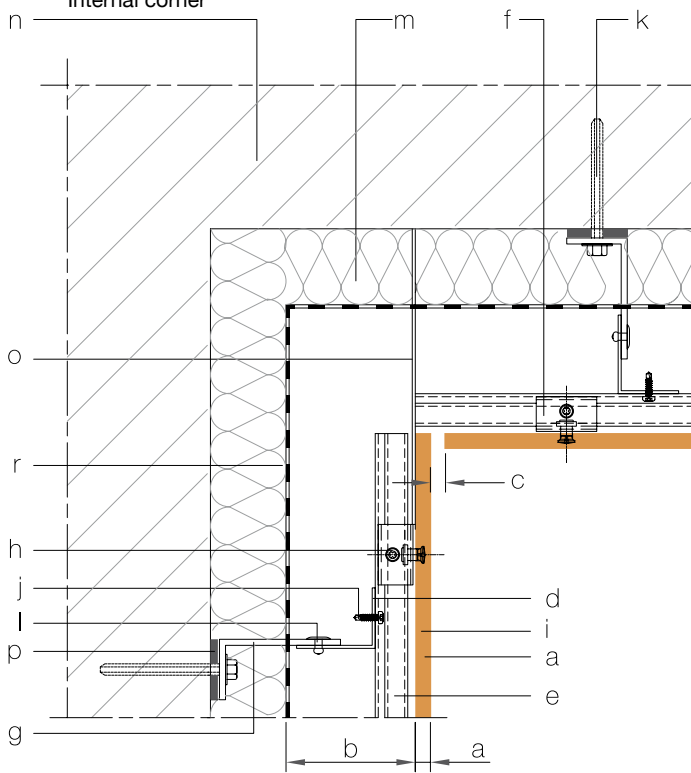

Figure 1  
Window detail

Figure 3  
Vertical panel joint

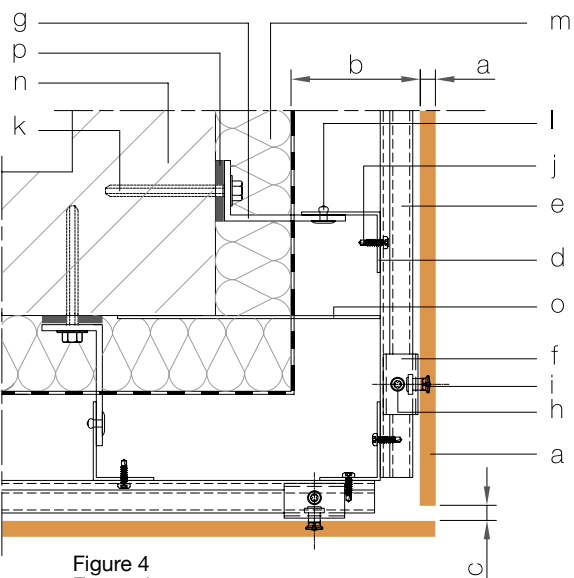
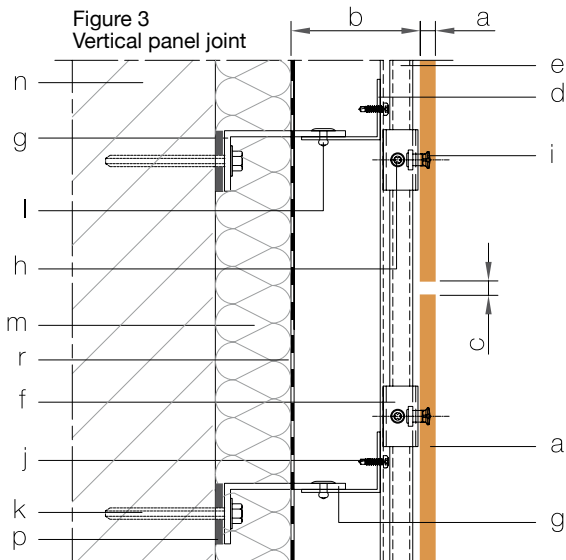

Figure 4  
External corner

Scale 1:5

- a VIVIX® panel thickness: 8 or 10 mm
- b Air cavity: 20 mm (min.)
- c Min. joint dimension: 10 mm
- d Primary profile
- e Secondary profile
- f Hook
- g Supporting bracket
- h Regulation screw
- i Fixing screw
- j Self-drilling screw
- k Anchor bolt
- l Fixing bracket
- m Thermal insulation
- n Load bearing wall
- o Aluminium plate (air cavity interruption)
- p Bridge bearing rubber pads
- q Window
- r Weather resistive barrier

**Construction details**  
**Metal substructure**  
 Concealed metal attachment  
 Vertical cross-section

Scale 1:10

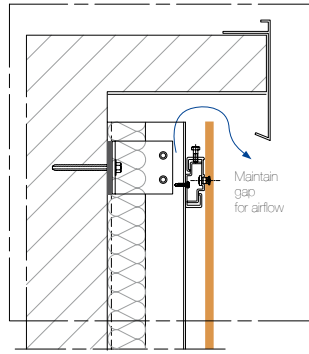

Figure 1

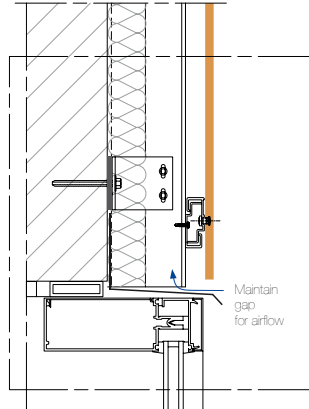

Figure 2

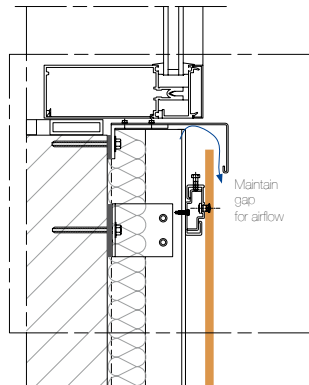

Figure 3

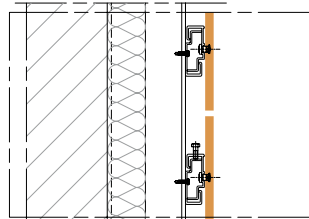

Figure 4

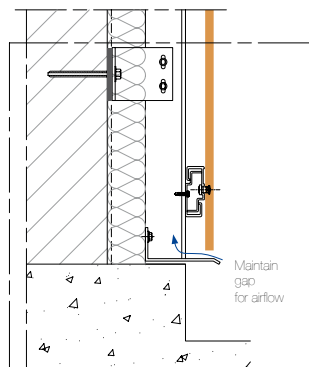

Figure 5

*This drawing indicates a typical fixing arrangement on a metal supporting structure. Please contact your Formica Group representative for other possibilities. Any information or suggestions concerning applications, specification or compliance with regulations and standards is provided solely for your convenient reference and without any representation as to accuracy or suitability. The user must verify and test the suitability of any information or products for his or her particular purpose or specific application.*

*Technical drawings in this brochure should be considered as general examples of how VIVIX® panels can be installed, there are other profiles and systems available in the market for ventilated façades which are not shown in this brochure. Consideration needs to be given to local circumstances, for example climate, wind load and local building regulations.*



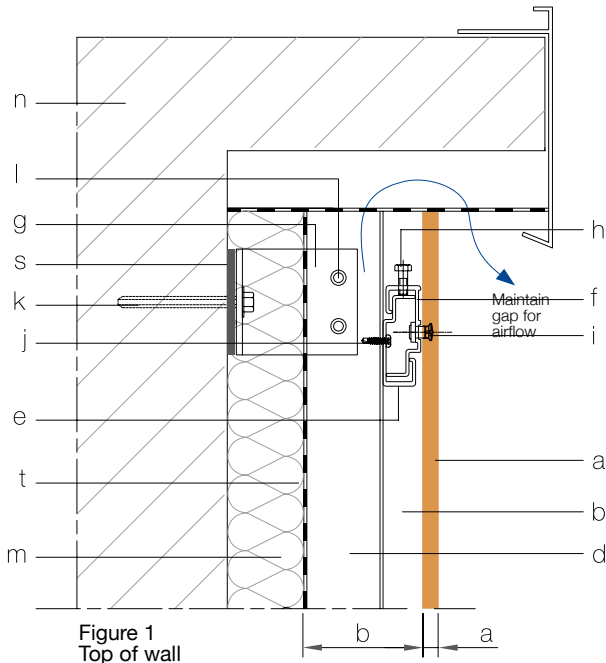

Figure 1  
Top of wall

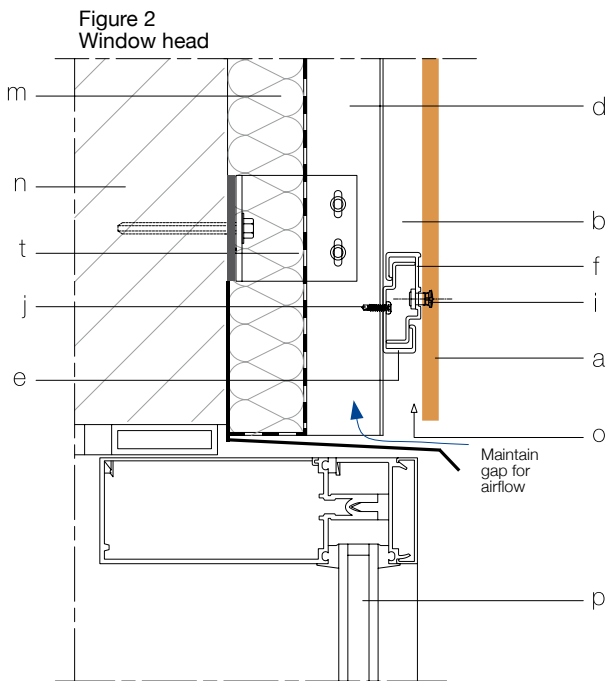

Figure 2  
Window head

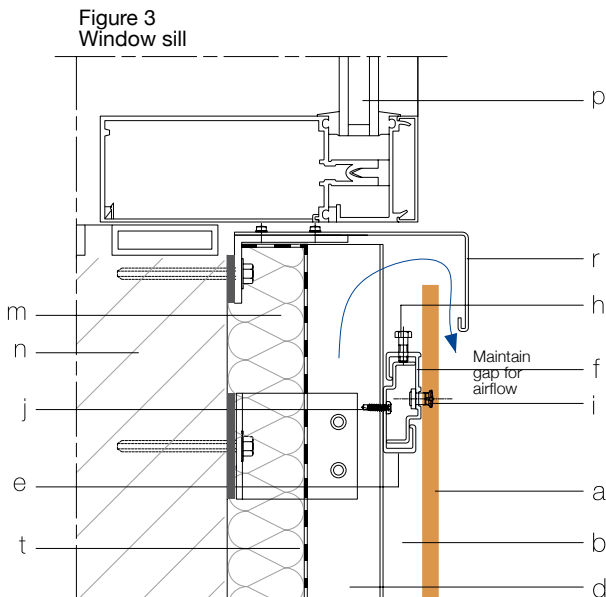

Figure 3  
Window sill

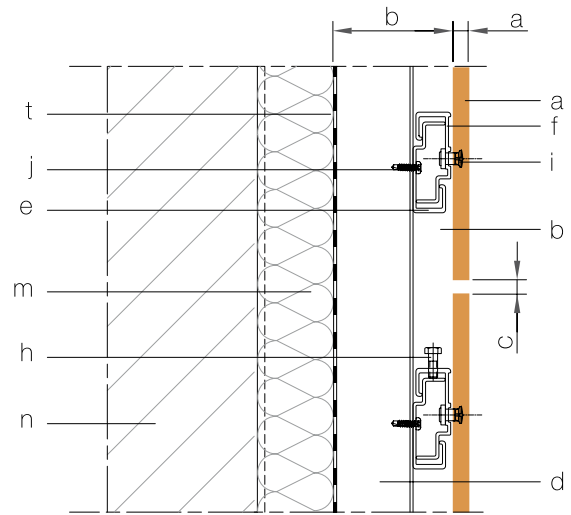

Figure 4  
Horizontal panel joint

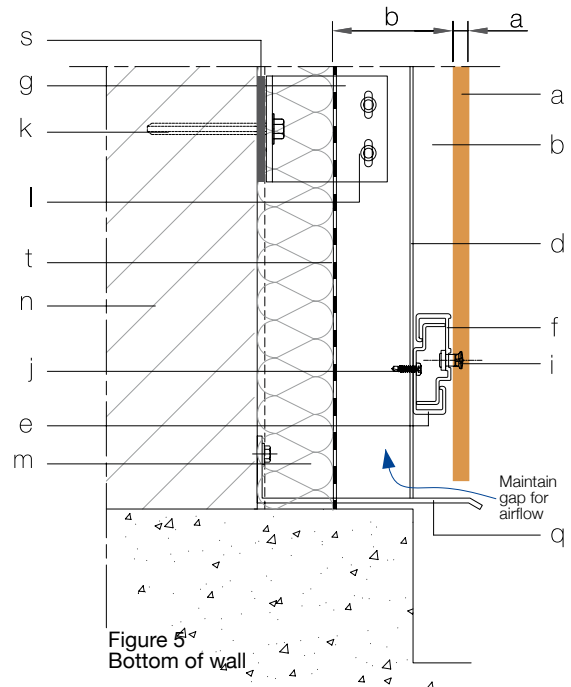
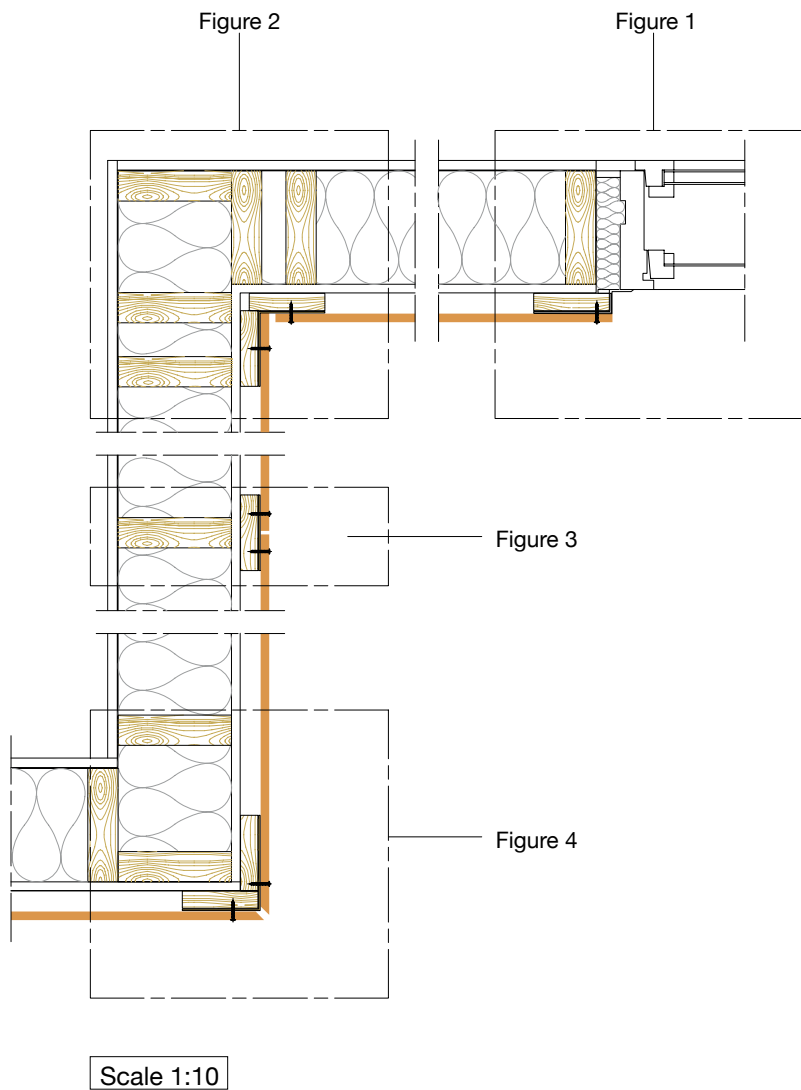

Figure 5  
Bottom of wall

Scale 1:5

- a VIVIX® panel thickness: 8 or 10 mm
- b Air cavity: 20 mm (min.)
- c Min. joint dimension: 10 mm
- d Primary profile
- e Secondary profile
- f Hook
- g Supporting bracket
- h Regulation screw
- i Fixing screw
- j Self-drilling screw
- k Anchor bolt
- l Fixing bracket
- m Thermal insulation
- n Load bearing wall
- o Ventilation area: 50 cm<sup>2</sup>/m (min.)
- p Window
- q Formed metal sheet
- r Formed metal sill flashing
- s Bridge bearing rubber pads
- t Weather resistive barrier

**Construction details**  
**Wooden substructure**  
 Visible attachment  
 Horizontal cross-section



*This drawing indicates a typical fixing arrangement on a wooden supporting structure. Please contact your Formica Group representative for other possibilities. Any information or suggestions concerning applications, specification or compliance with regulations and standards is provided solely for your convenient reference and without any representation as to accuracy or suitability. The user must verify and test the suitability of any information or products for his or her particular purpose or specific application.*

*Technical drawings in this brochure should be considered as general examples of how VIVIX® panels can be installed, there are other profiles and systems available in the market for ventilated façades which are not shown in this brochure. Consideration needs to be given to local circumstances, for example climate, wind load and local building regulations.*



Figure 2  
Internal corner

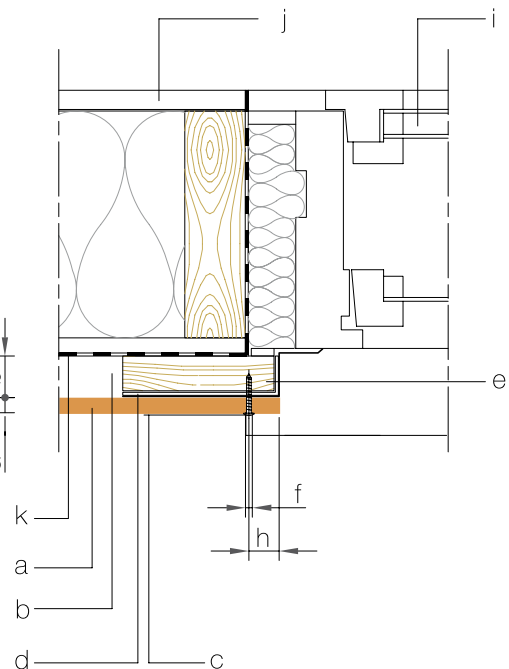
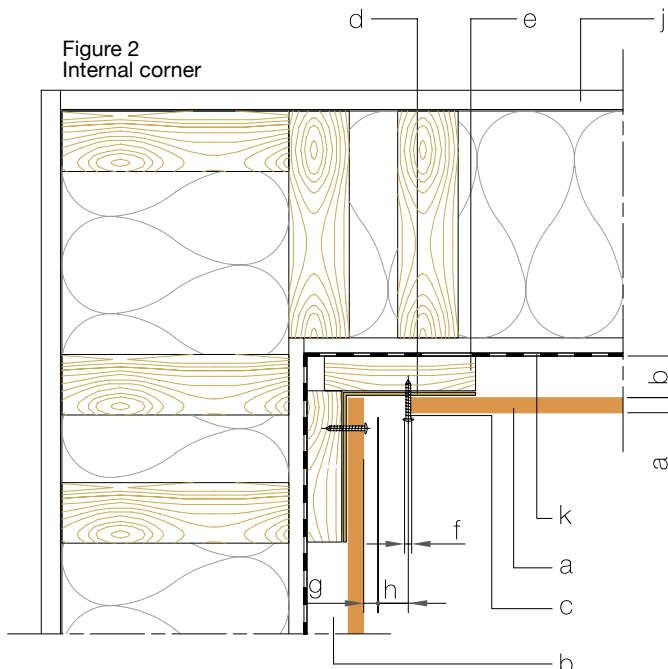

Figure 1  
Window detail

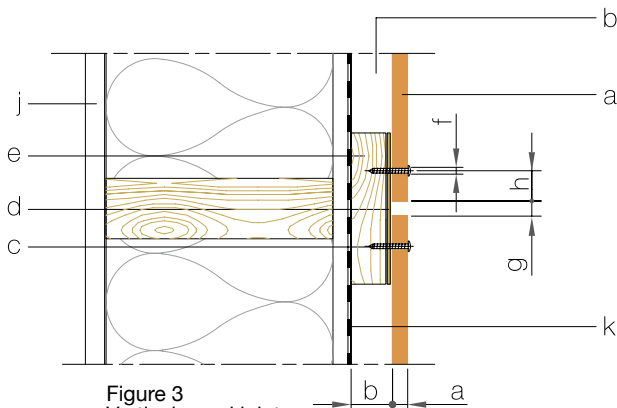

Figure 3  
Vertical panel joint

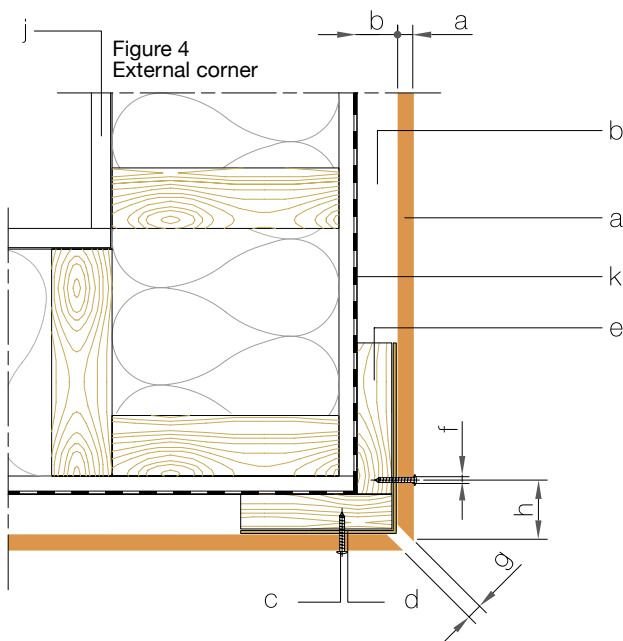

Figure 4  
External corner

Scale 1:5

- a VVIX® panel thickness: 6, 8 or 10 mm
- b Air cavity: 20 mm (min.)
- c Stainless steel screw
- d EPDM rubber strip
- e Vertical timber batten
- f Hole diameter: 1.5 x stainless screw diameter
- g Min. joint dimension: 10 mm
- h Edge distance: min. 20 mm - max. 10 x panel thickness
- i Window
- j Load bearing wall
- k Weather resistive barrier

**Construction details**  
**Wooden substructure**  
**Visible attachment**  
**Vertical cross-section**

Scale 1:10

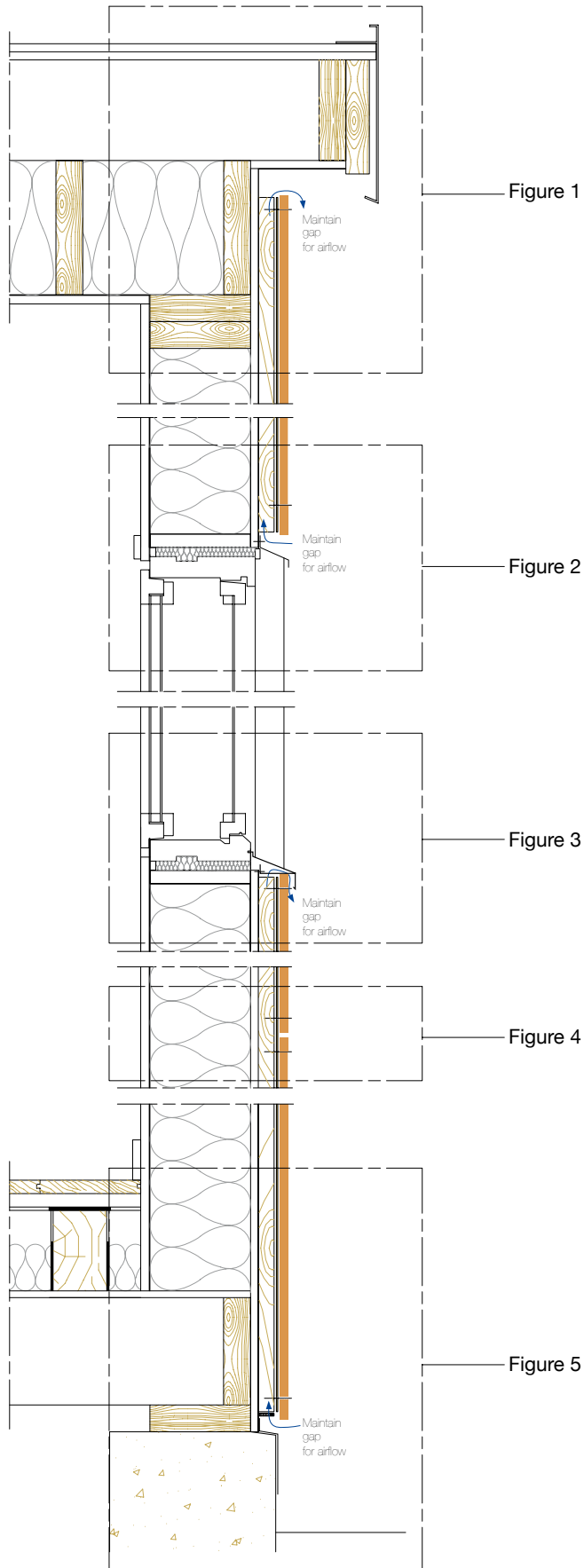

*This drawing indicates a typical fixing arrangement on a wooden supporting structure. Please contact your Formica Group representative for other possibilities. Any information or suggestions concerning applications, specification or compliance with regulations and standards is provided solely for your convenient reference and without any representation as to accuracy or suitability. The user must verify and test the suitability of any information or products for his or her particular purpose or specific application.*

*Technical drawings in this brochure should be considered as general examples of how VIVIX® panels can be installed, there are other profiles and systems available in the market for ventilated façades which are not shown in this brochure. Consideration needs to be given to local circumstances, for example climate, wind load and local building regulations.*



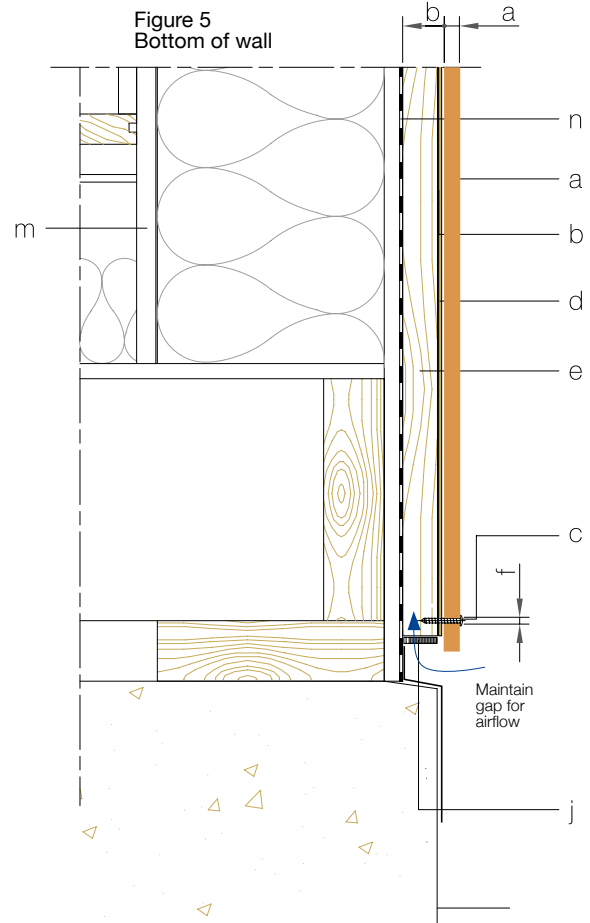
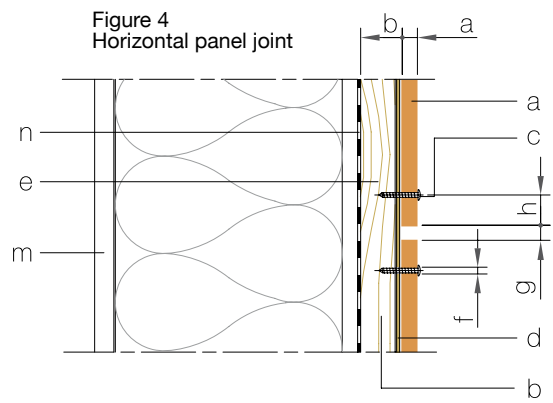
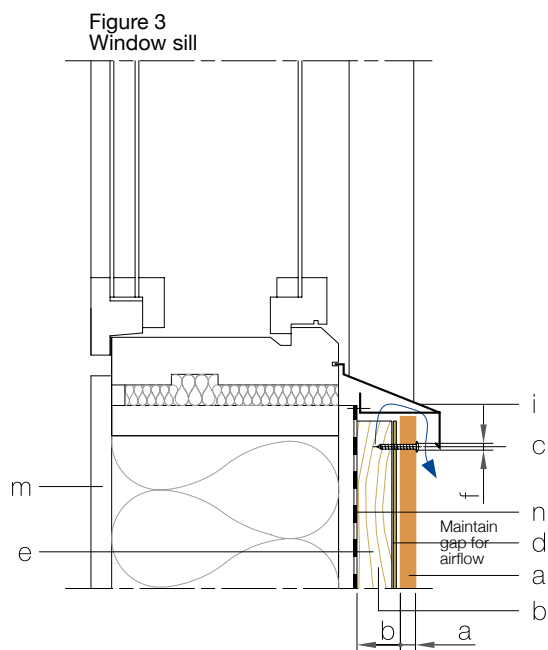
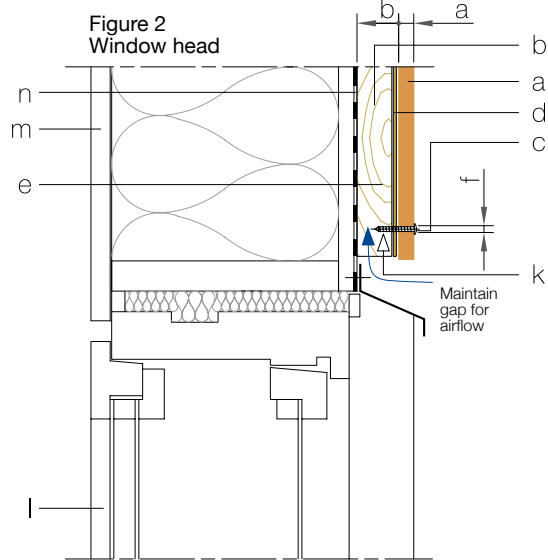
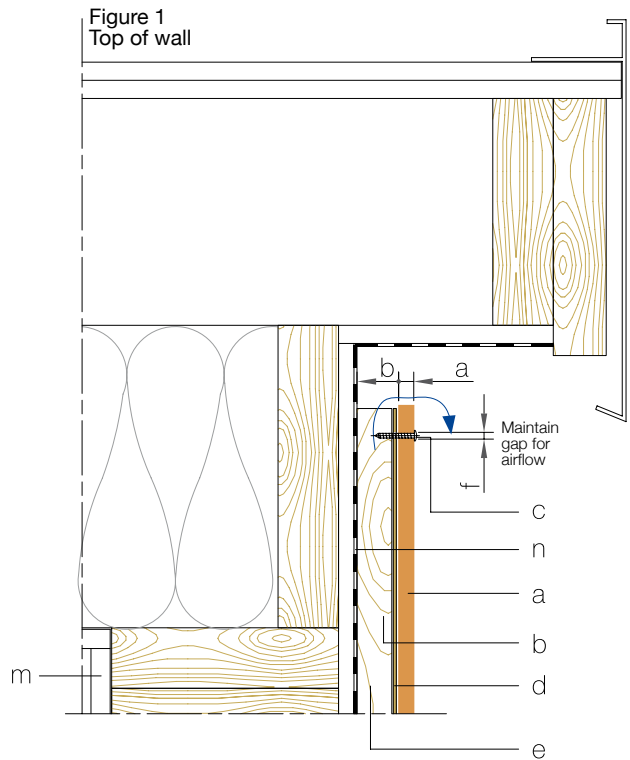

Scale 1:5

- a VIVIX® panel thickness: 6, 8 or 10 mm
- b Air cavity: 20 mm (min.)
- c Stainless screw
- d EPDM rubber strip
- e Vertical timber batten
- f Hole diameter: 1.5 x stainless screw diameter
- g Min. joint dimension: 10 mm
- h Edge distance: min. 20 mm - max. 10 x panel thickness
- i Formed metal sheet
- j Ventilation grille
- k Ventilation area: 50 cm<sup>2</sup>/m (min.)
- l Window
- m Load bearing wall
- n Weather resistive barrier

## The building envelope

VIVIX® installations utilising the rainscreen system contribute to seven areas of the LEED credits across several LEED rating systems. In order to be recognized by these rating systems, they must have various sustainable attributes. One of the most important is the system's durability. Because of its long lifespan, there are no refurbishments required and very little maintenance. Using a ventilated insulated rainscreen cladding system means less material replacements and considerably lower maintenance costs over the lifetime of the building or structure.

The rainscreen cladding system is used in conjunction with VIVIX architectural panels for the exterior of the building enclosure. It is especially resistant to both mold and moisture build-up, which directly contributes to the quality of the living environment. It also helps insulate the exterior of a building, which helps to address any thermal bridging issues.

The biggest benefit of using rainscreen systems is the temperature regulation and its ability to accommodate for the use of exterior insulation. This will help buildings comply with ASHRAE 90.1 building codes ([www.ashrae.org](http://www.ashrae.org)) which will require a continuous energy barrier, preventing thermal bridging which causes energy loss and building envelope inefficiency.

The ventilated rainscreen cladding system, on its own, also helps to cool the building as most of the sun's rays are reflected away. Additionally, any heat that does in fact pass through the exterior wall dissipates because of the ventilating effect of the air space between the exterior cladding VIVIX panel and the structural wall itself. Ultimately, any residual heat that does penetrate the building is very minor.

The VIVIX architectural panels act as a rainscreen and keep the structural wall dry. This is because the air space that connects to the outside air evacuates both water and humidity that may have penetrated behind the panels through the joints. This water will in fact never reach the load bearing walls or any of the thermal insulation.

## Components of the ventilated façade

### VIVIX architectural panels - a variety of sizes

The choice of panel formats provides flexibility to adapt the panels in the most cost effective and suitable combination for façades or building elements. Please refer to page 45 for specific panel sizes.

### Substructure

The substructure may be made up of:

- Metallic brackets (L)
- Vertical profile (T)
- Timber battens

### Elements used for attachment of VIVIX panels to the substructure

Panels are attached to the substructure using screws, rivets or other hidden attaching devices.

## Calculations for façade systems

### Loads to be taken into consideration

The loading to be factored into calculating the façade system is worked out using the weight of the panels themselves and the wind load. The effects of variations in temperature or humidity do not need to be taken into account when the system has been calculated and executed properly.

The installer must take into account local wind load and national building regulations.

## VIVIX panel weights

Thickness      4.5 mm    6 mm      8 mm      10 mm

Weight per m<sup>2</sup>   6.5 kg      8.7 kg      11.6 kg   14.5 kg

Note: EN438 minimum density is 1.35 gr/cm<sup>3</sup>.

## Wind load

Wind load is transmitted through panels to the substructure and unloaded through the supporting wall.

Calculations are performed on a project basis by assigned engineers. Please contact your preferred system manufacturer or installer who will be able to provide the necessary values and calculations. Your Formica Group representative can provide contact information, if necessary.

## Design

The following recommendations need to be taken into consideration:

- The minimum distance between a drilled hole and the edge of the VIVIX panel should be 20 mm (or 75 mm concealed) and the maximum distance should be the panel thickness x 10.
- The minimum space between VIVIX panels should be no less than 10 mm.
- The maximum distance between screws/rivets depends on the thickness of the panel:

	6 mm	8 mm	10 mm
2 fixings in one direction	450 mm	600 mm	750 mm
3 or more fixings in one direction	600 mm	750 mm	900 mm

- VIVIX panels in 4.5 mm thickness can for example be used in balcony panel applications.
- The maximum distance between screws/rivets for 4.5 mm thick panels is 300 mm.
- A minimum of 6 mm thickness is recommended for façade cladding.

## Setting up the system

The system should be installed by skilled and experienced fitters using the appropriate tools and equipment.

The system profile should be perfectly level and flat, particularly when using panels of 6 mm thickness.

The system manufacturer's instructions must be followed carefully especially with regard to the attachment of the parts of the profile to allow for its expansion differential for thermal loads.

VIVIX panels should be pre-conditioned, outdoors on site, for a period of 72 hours before installation.

Care should be taken to shield the protective film on the surface of the panels from solar radiation or other heat sources during pre-conditioning and storage.

The protective film should be removed from both sides of the panel simultaneously before installation.

VIVIX architectural panels, should be transported packed on the specially supplied pallets and should be stored on flat pallets and covered with a cap sheet. Care should be taken to shield the protective film on the surface of the panels from solar radiation or other heat sources during pre-conditioning and storage.

Lift the panels straight up, do not slide the panels against each other.

The protective film should be removed from both sides of the panel simultaneously before installation.



# Physical properties

Property	Standard & Clause	Standard Value	
		EDF Exterior grade, severe use, flame-retardant grade	EDS Exterior grade, severe use, standard grade
Thickness Tolerance	EN 438-2-5	4.5 mm +/-0.3 mm 6 mm +/-0.4 mm 8 mm +/-0.5 mm 10 mm +/-0.5 mm	
Flatness Tolerance	EN 438-2-9	4.5 mm 8 mm/m 6 mm 5 mm/m 8 mm 5 mm/m 10 mm 3 mm/m	
Length Width Tolerance	EN 438-2-6	+10 mm/-0	
Straightness of Edge Tolerance	EN 438-2-7	1.5 mm/m max deviation	
Flexural Modulus	EN ISO 178	9000 MPa (min)	
Flexural Strength	EN ISO 178	80 MPa (min)	
Tensile Strength	EN ISO 572-2	60 MPa (min)	
Density	EN ISO 1183	1.35 g/cm <sup>3</sup> (min)	
Impact Resistance	EN 438-2-21	height 1800 mm (D = 10 mm. max.)	
Resistance to Wet conditions	EN 438-2-15	mass increase 8% (max) appearance grade 4 (min)	mass increase 5% (max) appearance grade 4 (min)
Dimensional Stability at Elevated Temperature	EN 438-2-17	L 0.3% (max) T 0.6% (max)	
Resistance to UV Light	EN 438-2-28	contrast min 3 after 1500 hrs appearance min 4 after 1500 hrs	
Resistance to Artificial Weathering	EN 438-2-29	contrast min 3 after 650 MJ/m <sup>2</sup> appearance min 4 after 650 MJ/m <sup>2</sup>	
Resistance to Climatic Shock	EN 438-2 - 19	flexural strength index (Ds) 0.95 (min) flexural modulus index (Dm) 0.95 (min) appearance grade 4 (min)	
Fire Test (SBI)	EN 13501-1	B-s1,d0 (≥ 6 mm)	D-s2,d0
Oxygen Index	ISO 4589-2	45% (min)	
Thermal Conductivity	EN 12524	0.3 w/mk	

Formica Group is committed to making sustainable principles and practices a part of everything we do. We strive to adhere to the highest ethical standards as we advance in our efforts to protect vital resources for future needs.

F5513  
Redwood





VIVIX®

A FRESH PERSPECTIVE IN ARCHITECTURAL PANELS by FORMICA GROUP



**Austria**

Tel: +49 (0) 180 367 64 22  
austria@formica.com

**Belgium**

Tel: +32 2 705 18 18  
contact.belgie@formica.com

**Denmark**

Tel: +45 43 58 82 00  
info.danmark@formica.com

**Finland**

Tel: +358 3 5800 200  
info.finland@formica.com

**France**

Tel: +33 (0) 3 87 29 10 13  
service.echantillons@formica.com

**Germany**

Tel: +49 (0) 180 367 64 22  
kontakt.deutschland@formica.com

**Holland**

Tel: +31 (0) 70 413 48 20  
contact.nederland@formica.com

**Ireland**

Tel: +353 1 872 4322  
samples.uk@formica.com

**Italy**

Tel: +39 011 9027092  
italia@formica.com

**Middle East**

Tel: +971 4 3298280  
middle.east@formica.com

**Morocco**

Tel: +212 (0) 522472047  
administration.maroc@formica.com

**Norway**

Tel: +47 800 13 016  
info.norge@formica.com

**Poland**

Tel: +48 22 516 20 84/85  
info.polska@formica.com

**Russia**

Tel: +7 495 646 07 25  
Samples tel: +8 800 333 11 63  
russia@formica.com

**Spain**

Tel: +34 94 457 96 35  
contact.es@formica.com  
muestras@formica.com

**Sweden**

Tel: +46 42 38 48 00  
info.sverige@formica.com

**Switzerland**

Tel: +41 44 818 88 18  
schweiz@formica.com

**United Kingdom**

Tel: +44 191 259 3100  
Samples tel: +44 191 259 3512  
samples.uk@formica.com

formica.com

